can-am[®]

**OUTLANDER
RENEGADE**

ACCESSORIES,
RIDING GEAR &
GENUINE PARTS



YOUR SEARCH FOR THE PERFECT ACCESSORIES STARTS & ENDS HERE

YOUR GUIDE TO ESSENTIAL FACTORY DEVELOPED AND APPROVED
ACCESSORIES FOR YOUR CAN-AM.



FIT & COMPATIBILITY

Innovative accessories that are simply better, together. Fit, function and looks—right out of the box—with the peace of mind that the accessories you pick will work perfectly with hundreds of others.



QUALITY & RELIABILITY

Quality and reliability so good, it comes with a 1-year warranty. We stand strong behind our Genuine Can-Am accessories... because we can. Install them yourself or at an authorized dealer and immediately upgrade your off-road vehicle without worry.



STYLE & VISION

Can-Am designers develop vehicles and accessories that look and perform right because they're for riders, period. Everything in this guide is here to benefit your experience—nothing else made the cut.

BRP 1-YEAR LIMITED WARRANTY*

For new Can-Am accessories, genuine parts, and co-branded products sold through BRP¹. Includes items installed by you or an authorized BRP dealer.

can-am

¹Use other than which the product is designed for will void the product lifetime warranty. ²Applies only to BRP-made products or co-branded products made by accredited BRP partners (Lonestar Racing for Can-Am, DragonFire for Can-Am, S3 for Can-Am, Beard Seats for Can-Am, Baja Designs for Can-Am, etc.). Purchased at an authorized BRP dealership / distributor or on a BRP-authorized online store. Other exclusions may apply, see complete limited warranty or contact your Can-Am off-road authorized dealer. ³Includes only BRP-approved aftermarket products and products made by currently accredited BRP partners. ⁴Unless otherwise stipulated or required by law. This limited warranty does not apply to factory installed accessories. This limited warranty does not apply to Evinrude parts and accessories. This limited warranty is effective as of March 1st, 2016.

can-am
OUTLANDER
RENEGADE

**1
2
3
4
5
6
7
8
9
10
11
12
13
14
15
16
17
18
19
20
21
22
23
24
25
26
27
28
29
30
31
32
33
34
35
36
37
38
39
40
41
42
43
44
45
46
47
48
49
50
51
52
53
54
55
56
57
58
59
60
61
62
63
64
65
66
67
68
69
70
71
72
73
74
75
76
77
78
79
80**



HEAVY-DUTY PROTECTION
 Ranch and work-ready bumper.
 P.34



PROMOUNT
— PLOWS

THE POWER TO PUSH FORWARD

Designed to work as efficiently as possible, Can-Am reimaged the plow from frame to blade.
 P.54



APACHE
 TRACK SYSTEMS

TERRAIN IS NO LONGER THE LIMIT

Get the most out of your Can-Am vehicle this winter for all your endeavors.
 P.49

- 4 **ACCESSORIES**
- 4 Built Inspirations
- 8 Compatibility Guide
- 9 LinQ: Easy On Easy Off Cargo
- 17 Cargo & Storage
- 20 Windshields
- 23 Handlebars & Mirrors
- 24 Seat Kits

- 25 Racks & Holders
- 28 Skid Plates
- 32 Bumpers & Guards
- 37 Lights & Electrical
- 41 Winches
- 43 Hitches
- 44 Performance
- 48 Covers, Decals & Add-Ons

- 49 Apache™ Track Systems
- 54 Promount Plows
- 59 Tires
- 60 Rims
- 62 **RIDING GEAR**
- 64 Can-Am Sportswear
- 65 Mud Gear
- 66 Helmets

- 67 Dust Masks / Communication Systems
- 68 Goggles / Gloves / Junior
- 69 Bags / Sizing Chart
- 70 Branded Merchandise
- 72 **PARTS & MAINTENANCE**
- 72 Genuine Can-Am Parts
- 78 XPS Oils & Maintenance



CREATE YOUR OWN WINDSHILED
 Modular windscreen protection options for any rider preference.
 P.20

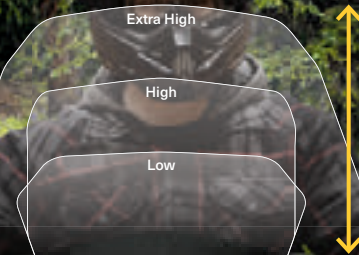

LinQ
 SYSTEM™
NO MORE BUNGEE'S & ROPES
 P.9

EXPERT CHOICE Look for this logo throughout the catalogue for Expert recommendations on innovative, must-have, enthusiast-ready parts and accessories that will help you customize your perfect off-road machine.

ENGINE OIL CHANGE KIT
 Want to save time and money? Use the ultra-convenient "all-in-one" DIY Engine Oil Change Kit.
 P.78



HARD WORK

TAKE ON THE TOUGH TASKS WITH UTILITY UPGRADES THAT WORK SEAMLESSLY AND TIRELESSLY WITH YOU & YOUR OUTLANDER



OUTLANDER

TAKE YOUR PICK: Expertly-chosen STARTER, ADVANCE, and PEAK utility packages to take your Can-Am build to another level. Or simply mix and match and create your own package.

STARTER	715001215	LinQ Heavy-Duty Basket	P.15	\$269.99
	715001914	8" (20 cm) Rack Extension	P.26	\$154.99
	715006108	Warn VRX 35 Winch	P.41	\$609.99
	+			\$1,034.97
ADVANCE	715001909	Fender Flares	P.36	\$169.99
	715003461	Rancher Front Bumper	P.34	\$349.99
	715003462	Rancher Rear Bumper	P.34	\$299.99
PEAK	715003459	Body Side Protector	P.35	\$384.99
	+			\$2,239.93
	715001945	Multi-Fit Holder	P.27	\$81.99
	710005423	Ram LED Spotlight	P.39	\$149.99
	715005186	Rear Hitch Receiver	P.43	\$116.99
	715000972	Front & Rear Hitch Drawbar	P.43	\$91.99
				\$2,680.89

*Note that price does not include installation requirements and that part numbers may vary depending on vehicle model.



YOU CAN FINANCE THE PURCHASE OF ACCESSORIES

with the purchase and financing of your Outlander. Ask your dealer for all the details.

TRAIL

GO FARTHER WITH PROVEN TRAIL ACCESSORIES FOR ALL-DAY COMFORT & RELIABILITY



OUTLANDER MAX

TAKE YOUR PICK: Expertly-chosen STARTER, ADVANCE, and PEAK trail packages to take your Can-Am build to another level. Or simply mix and match and create your own package.

STARTER	715001749	LinQ Trunk Box Outlander Max	P.13	\$544.99
	715006119	LinQ Trunk Box Pannel	P.13	\$61.99
	715001232	Deluxe Fairing	P.21	\$254.99
	715001211	High Windshield for Deluxe Fairing	P.21	\$86.99
	715004837	XT Front Bumper	P.33	\$214.99
	715004920	XT Rear Bumper	P.33	\$214.99
	+			\$1,378.94
ADVANCE	715001286	Extreme Front Bumper	P.35	\$314.99
	715002353	Deluxe Mirror Kit	P.21	\$76.99
	715003115	Auxiliary Windshield Lights	P.39	\$399.99
	715003250	Heated Hand Grips & Throttle Combo	P.37	\$284.99
	715001926	Heated Passenger Grips & Visor Outlet	P.37	\$264.99
	+			\$2,720.89
PEAK	715004284	Baja Design High Beam Kit	P.39	\$769.99
	715003942	Driver Backrest	P.24	\$289.99
	715004807	HMWPE Skid Plate	P.28	\$854.97
				\$4,635.84

*Note that price does not include installation requirements and that part numbers may vary depending on vehicle model.



YOU CAN FINANCE THE PURCHASE OF ACCESSORIES

with the purchase and financing of your Outlander MAX. Ask your dealer for all the details.

WINTER

FINALLY ENJOY WINTER WITH COLD-WEATHER ESSENTIALS: THE CAN-AM APACHE TRACK SYSTEM & PROMOUNT PLOW KIT



OUTLANDER MAX

TAKE YOUR PICK:

Expertly-chosen STARTER and ADVANCE packages are the best way to quickly add cold-weather upgrades—plus plow and tracks for even more winter use. Or mix and match to create your perfect snow-ready Outlander.

STARTER	715004282	LinQ Low Profile Basket	P.15	\$209.99
	715003023	Extra-High Windshield Kit	P.22	\$284.99
	715004815	Heated Grips & Thumb Throttle Combo	P.37	\$284.99
	715001246	Heated Visor Outlet	P.37	\$66.99
	+			\$846.96
ADVANCE	715001926	Heated Passenger Grips & Visor Outlet	P.37	\$264.99
	715004301	LinQ Tool Box	P.11	\$179.99
	715005111	Fender Flare Extensions	P.36	\$259.99
	715004293	2" (5 cm) Square LED Lights	P.39	\$204.99
				\$1,756.92
TRACKS	715005103	Apache 360LT Track System	P.51	\$4,999.99
	715004795	Apache 360LT Mounting Kit	P.53	\$274.99
	715003063	Apache 360 LT Adaptor	P.53	\$179.99
				\$7,211.89
PLOW	715006109	Warn VRX 35-S Winch	P.41	\$739.99
	715005202	Can-Am ProMount Flex2 60" (152 cm) Kit	P.56	\$989.97
	715004204	Can-Am ProMount Push Frame Extension	P.57	\$179.99
	715004207	Can-Am Promount Drift Cutters	P.58	\$149.99
	715004206	Can-Am Promount Edge Markers	P.58	\$49.99
				\$9,321.82

*Note that price does not include installation requirements and that part numbers may vary depending on vehicle model.



YOU CAN FINANCE THE PURCHASE OF ACCESSORIES

with the purchase and financing of your Outlander MAX. Ask your dealer for all the details.

HUNTING

ADAPT QUICKLY FOR THE HUNT BY OUTFITTING THE OUTLANDER TO YOUR EXACT NEEDS



OUTLANDER

For the international market, the Squadron Green color is only available on the Outlander 570 PRO.

TAKE YOUR PICK:

Expertly-chosen STARTER, ADVANCE, and PEAK hunting packages to take your Can-Am build to another level. Or simply mix and match and create your own package.

STARTER	715003248	LinQ Premium Storage Bag by Ogio	P.15	\$579.99
	715003021	Low Windshield kit	P.22	\$194.99
	715001419	Gun Boot 6.0 Impact by Kolpin	P.27	\$87.99
	715001918	Gun Boot Rack	P.27	\$149.99
	+			\$1,012.96
ADVANCE	715004282	LinQ Low Profile Basket	P.15	\$209.99
	715001910	XT Front Bumper	P.33	\$174.99
	715001911	XT Rear Bumper	P.33	\$134.99
	715003614	Body Side Protector	P.35	\$419.99
	715004279	Extreme Front Bumper	P.35	\$289.99
	715001909	Fender Flares	P.36	\$169.99
	+			\$2,412.90
PEAK	715004199	Aluminum Skid Plate	P.29	\$874.93
	715003250	Heated Grips & Thumb Throttle Combo	P.37	\$284.99
	710005423	RAM LED Sportlight	P.39	\$149.99
	715006415	Can-Am HD 3500 winch	P.41	\$379.99
				\$4,102.80

*Note that price does not include installation requirements and that part numbers may vary depending on vehicle model.



YOU CAN FINANCE THE PURCHASE OF ACCESSORIES

with the purchase and financing of your Outlander. Ask your dealer for all the details.

ATV ACCESSORY COMPATIBILITY GUIDE

We've made things super simple.

- Check your **model year**
- Choose **engine** and **model**
- Learn your **PLATFORM CODE**

This **PLATFORM CODE** will let you know at a glance if the accessory is compatible with your vehicle.

EXAMPLE

CARGO BAG

- Rugged all-purpose cargo bag with rain cover for additional protection against the elements.
- LinQ Luggage Rack (715001734) is required for G2S.

G2, G2L, G2S

280000539
\$189.99

For G1 accessories, refer to your local dealer.

Model Year	Model	Engine Configuration	Platform Code
2013	Outlander	400	G1
	Outlander	500, 650, 800, 1000	G2
	Outlander MAX	400	G1
	Outlander MAX	500, 650, 800	G2
	Renegade	500, 800, 1000	G2S
2014	Outlander	400	G1
	Outlander	500, 650, 800, 1000	G2
	Outlander MAX	400	G1
	Outlander MAX	500, 650, 800, 1000	G2
	Renegade	500, 800, 1000	G2S
2015	Outlander L	450, 500	G2L
	Outlander	500, 650, 800, 1000	G2
	Outlander L MAX	450, 500	G2L
	Outlander MAX	500, 650, 800, 1000	G2
	6x6	650, 1000	G2
	Renegade	500, 800, 1000	G2S
	Renegade	500, 800, 1000	G2S
2016	Outlander L	450, 570	G2L
	Outlander	570, 650, 850, 1000	G2
	Outlander L MAX	450, 570	G2L
	Outlander MAX	570, 650, 850, 1000	G2
	6x6	650, 1000	G2
2017 2018	Outlander	450, 570	G2L
	Outlander	650, 850, 1000	G2
	Outlander MAX	450, 570	G2L
	Outlander MAX	650, 850, 1000	G2
	6x6	650, 1000	G2
2019 2020	Renegade	570, 850, 1000	G2S
	Outlander	450, 570	G2L
	Outlander	650, 850, 1000, 1000R	G2
	Outlander MAX	450, 570	G2L
	Outlander MAX	650, 850, 1000, 1000R	G2
	6x6, 6x6 MAX	450	G2L
	6x6, 6x6 MAX	650, 1000	G2
Renegade	570, 850, 1000, 1000R	G2S	



G2L 6x6

G2 6x6

G2

G2L



G2S

G1

G1S

LinQ SYSTEM™

EASY ON EASY OFF CARGO

A BRP exclusive, LinQ is a tool-less system for near-instant installation of accessories. Quickly, easily install and remove LinQ accessories to transform your machine to fit the moment.



FIT & COMPATIBILITY



QUALITY & RELIABILITY



STYLE & VISION



TOOL-LESS

Twist LinQ fasteners and go!

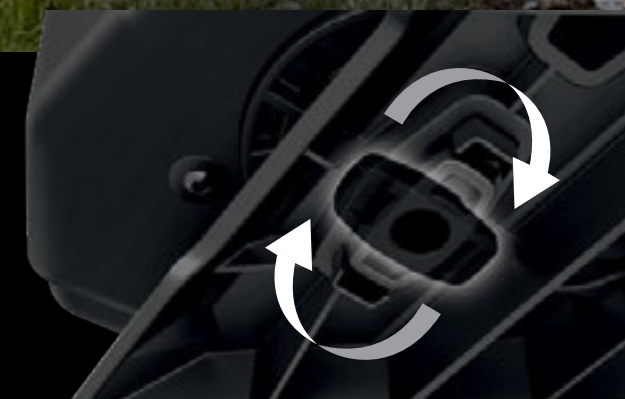

YOUR ADVENTURE, OUTFITTED

LinQ trunk boxes, rack extensions, bags, baskets, and gear grips attach quickly for your next expedition.

LinQ ACCESSORY TYPES

- **LinQ** with 16" base accessories are mounted with LinQ anchors 16 inches apart, ideal for Can-Am ATVs and SSVs, Sea-Doo watercraft, and Ski-Doo snowmobiles.
- **LinQ** with 36" base accessories are most commonly used as part of LinQ racks for Can-Am Off-Road vehicles.

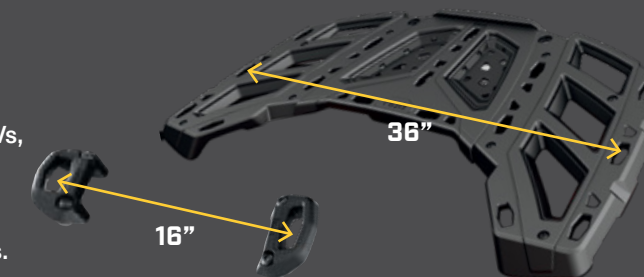

LinQ SYSTEM ACCESSORIES





- No tools needed: Quickly install and remove accessories by hand
- Equip your Can-Am for specialized tasks in no time
- Sturdy mounting system that holds up to the roughest terrain

Compatibility/Requirements

Outlander 450/570 Outlander Renegade









LinQ ACCESSORIES WITH 16" BASE P. 11

- LinQ anchors mounted 16 inches apart, center-to-center.
- Lower loading capacity than the 36" base accessories.
- Can be used on Can-Am ATV and SSV vehicles, Sea-Doo watercraft and Ski-Doo snowmobiles.



	LinQ 4.2 GAL (16 L) COOLER 295100698	Not compatible	LinQ Anchor Adaptor Kit 715004960	LinQ Luggage Rack 715001734 + LinQ Anchor Adaptor Kit 715004960
	LinQ TOOL BOX 715004301			
	LinQ SR 5.5 GAL (21 L) BAG 860201740			
	LinQ 4.5 GAL (17 L) SPORT BAG 860201678			
	New LinQ DRY BAG 715002875			

LinQ ACCESSORIES WITH 36" BASE P. 12-15

- Mount on LinQ racks often used by Can-Am ORV vehicles.
- Higher loading capacity than the 16" base accessories.
- Usage is limited to Can-Am ORV vehicles.

	LinQ 12 GAL (45 L) CARGO BOX 715003879	LinQ Base 715002350	No further requirements	LinQ Luggage Rack 715001734
	LinQ 23 GAL (86 L) GAL TRUNK BOX 715004923			
	LinQ 32 GAL (121 L) TRUNK BOX 715001747 / 715001749 (MAX)	Not compatible		
	LinQ 11.5 GAL (43 L) AUDIO CARGO BOX 715003018	LinQ Base 715002350		
	LinQ 8 GAL (30 L) COOLER BOX 715004778 • Black / 715004698 • Grey	Not compatible		
	LinQ PREMIUM STORAGE BAG BY OGIO 715002923 • Black / 715003248 • Camo	LinQ Base 715002350	No further requirements	LinQ Luggage Rack 715001734
	LinQ HEAVY-DUTY BASKET 715001215			
	LinQ LOW PROFILE BASKET 715004282			

LinQ RACKS & HOLDERS P. 25-27

	LinQ 4" (10 CM) RACK EXTENSION 715001711 • Silver / 715001665 • Black	Not compatible <i>*Alternative 5" or 8" Rack Extensions (715001913 or 715001914) are available for G2L</i>	No further requirements	LinQ Luggage Rack 715001734
	LinQ 6" (15 CM) RACK EXTENSION 715001712 • Silver / 715001671 • Black			
	LinQ MOUNTED GEAR GRIPS 715001351	Not compatible <i>*Alternative Gear Grips by Kolpin (715001421) are available for G2L</i>		
	LinQ TOOL HOLDER 715003059	LinQ Base 715002350		
	LinQ GUN BOOT RACK 715002112 / 715002113	Not compatible <i>*Alternative Gun Boot Racks (715001918 or 715001919) are available for G2L</i>		Not compatible

LinQ: EASY ON EASY OFF CARGO



BETTER RIDE,
ADDED CAPABILITY,
MORE STORAGE:
WHAT'S NOT
TO LOVE?

LinQ ACCESSORIES WITH 16" BASE

OUTLANDER | RENEGADE

LinQ 4.2 GAL (16 L) COOLER

- Rotomolded construction for exceptional rigidity and durability.
- Premium-quality foam insulation for optimal ice retention.
- Marinized for salt water purposes.
- See table for installation location and requirements.

G2, G2S
295100698
\$369.99



EXPERT CHOICE

One of the most versatile and popular coolers on the market made for rugged use.

LinQ TOOL BOX

- High precision injected HDPE construction provides rigidity and durability.
- 5 Gal (19 L) maximum capacity.
- Weather-resistant, sealed and lockable cover.
- LinQ Cargo Base Kit included (860201806).
- Marinized for salt water purposes.
- See table for installation location and requirements.

G2, G2S
715004301
\$179.99



SR 5.5 GAL (21L) LinQ BAG

- Semi-rigid expandable bag.
- 5.5 Gal (21L) capacity.
- LinQ Cargo Base Kit included (860201801).
- See table for installation location and requirements.

G2, G2S
860201740
\$224.99



New LinQ 4.5 GAL (17 L) SPORT BAG

- 17-liter 4.5 Gal (17 L) capacity.
- Rigid bottom, semi-rigid top.
- See table for installation location and requirements.
- LinQ Cargo Base Kit included.

G2, G2S
860201678
\$204.99



New LinQ DRY BAG

- Fully waterproof roll-top dry bag will securely store and confine your equipment.
- LinQ mounted using heavy-duty rigid plastic base.
- High capacity storage solution 10.6 Gal (40L).
- Bottom foam liner for additional equipment protection.
- Integrated handle for easy transportation on/off the vehicle.
- LinQ Cargo Base Kit included (860201806).
- Marinized for salt water purposes.
- See table for installation location and requirements.

G2, G2S
715002875
\$234.99





LinQ 12 GAL (45L) CARGO BOX

5" (13 CM) RACK EXTENSION

LinQ 23 GAL (86L) TRUNK BOX

LinQ ACCESSORIES WITH 36" BASE

OUTLANDER | RENEGADE

LinQ 12 GAL (45L) CARGO BOX

- LinQ mounted for easy on, easy off installation.
 - Holds cargo safely and securely while riding.
 - See table for installation location and requirements.
- G2 (front only for 6x6 & MAX models 2013-2014), G2L, G2S**
 715003879
\$284.99

LinQ 23 GAL (86L) TRUNK BOX

- LinQ mounted for easy on, easy off installation.
 - Lockable and weather-resistant.
 - Holds cargo safely and securely while riding.
 - Comfort pads for passenger.
 - See table for installation location and requirements.
- G2 (except 6x6 models), G2L, G2S**
 715004923
\$354.99



LinQ ACCESSORIES WITH 36" BASE

OUTLANDER | RENEGADE

LinQ 32 GAL (124L) TRUNK BOXES

Seamless integration with vehicle

- Built from the design stage to specifically match your Can-Am vehicle.
- Totally cohesive design eliminates the need to modify your vehicle in any way*.
- Rear tail light.

Color-keyed panels

- Colored Trunk Box Panels & Camo Decals are available to match your Outlander (sold separately).

Easy quick-attach installation

- Equipped with the LinQ System, the rear trunk box plugs in and out in seconds.
- Instantly transforms your vehicle to suit the need of the moment.

Unparalleled storage

- 32 Gal (124L) load capacity with contiguous unobstructed space to maximize storage room and access to the trunk's interior.

Built tough

- Made of injection-molded polyethylene, double walled in critical areas.

Dust and weather proof

- The fully sealed lid protects your belongings from dust, moisture and the elements.

Lockable

- Built-in lockable barrel.



LinQ 32 GAL (124L) TRUNK BOX

LinQ 32 GAL (124L) TRUNK BOX PANELS

Choose from 10 different colors to perfectly match your vehicle!

LinQ 32 GAL (124L) TRUNK BOX

- LinQ Retrofit Adaptor Plate (715001334) is required for G1 models.
- Trunk Box Panels available in many colors to match your vehicle (sold separately).
- See table for installation location and requirements.

G2 (except MAX models & 6x6), G2S
 715001747
\$449.99

European Version (EC compliant)
 • No rear tail light.
 715001748

LinQ 32 GAL (124L) TRUNK BOX FOR OUTLANDER MAX

- Passenger comfort is ensured on active rides as well as longer recreational rides thanks to the ergonomically designed passenger padding comfort-fitted with a portion made of closed cell foam that won't absorb water.
- Very easy to embark even when driver is seated.
- Trunk Box Panels available in many colors to match your vehicle (sold separately).

G2 (MAX models only except 6x6 models)
 715001749
\$544.99

EUROPEAN VERSION (EC compliant)
 • No rear tail light.
 715001750



EXPERT CHOICE

Add lockable storage, style, and passenger comfort—no tools needed.

LinQ 32 GAL (124L) TRUNK BOX PANELS

- Color panels to match the 32 Gal (124L) LinQ Trunk Box to your vehicle.

LinQ 32 Gal (124L) Trunk Boxes

- | | |
|------------------------|---------------------------------------|
| 715001391 • Black | 715002984 • Octane Blue |
| 715001392 • Yellow | 715002985 • Manta Green |
| 715001395 • Viper Red | 715002986 • Can-Am Red |
| 715002481 • White | 715006119 • Orange Crush New |
| 715002480 • Light Grey | 715006120 • Squadron Green New |
- \$61.99**

EUROPEAN VERSION (EC compliant)

- No rear tail light
- 715001397 • Black
- 715001398 • Yellow
- 715002482 • Light Grey
- 715002483 • White
- 715006121 • Can-Am Red **New**
- 715006122 • Manta Green **New**
- 715006123 • Orange Crush **New**
- 715006124 • Viper Red **New**

CAMO DECALS FOR BLACK TRUNK BOX PANELS

- (Not illustrated)
- Camo pattern perfectly matches your camo vehicle.
- LinQ 32 Gal (124L) Black Trunk Box Panel**
- 715002975 • Mossy Oak Break-Up Country Camo
 - 715001683 • Next G-1 Vista Camo
- \$56.99**



715002975

715001683

*WARNING: You should never accessorize your Can-Am off-road vehicle with accessories not approved by BRP because your vehicle may no longer meet certain safety and construction standards. This situation could increase the risk of severe injury or death and render your vehicle not legal for use.

TAKE ON THE TOUGH JOBS WITH TASK-FOCUSED UPGRADES THAT ALLOW YOUR CAN-AM ATV VEHICLE TO WORK SMARTER & HARDER



LinQ ACCESSORIES WITH 36" BASE

OUTLANDER | RENEGADE

LinQ 11.5 GAL [43L] AUDIO CARGO BOX

- Mounts on/off easily to hold/carry cargo safely and securely.
- The Bluetooth enabled receiver and 6.5" (16.5 cm) speakers are smartly concealed and integrated in the cover.
- Automatic shut-off function protects your battery by turning the system off after 10 minutes of inactivity.
- Backlit control panel perfect for night riding.
- Water-resistant speakers.
- Delivers the best sound quality on the market to sweeten your ride courtesy of a built-in full range high-efficiency amplifier.
- See table for installation location and requirements.

G2 (front only for 6x6 & MAX models 2013-2014), G2L, G2S

715003018

\$694.99



EXPERT CHOICE

Quickly attach or remove for ultimate sound and added storage, anytime.

LinQ 8 GAL [30L] COOLER BOX

- LinQ mounted for easy on, easy off installation.
- Rotomolded construction provides exceptional rigidity and durability.
- Premium-quality foam insulation for optimal ice retention.
- Integrated, fully-removable compartment protects food.
- Robust rubber latches keep the cover tightly closed.
- Weather-resistant.
- Convenient drain plug.
- See table for installation location and requirements.

G2 (except 6X6 models), G2S

715004778 • Black

\$459.99

G2 (except 6x6 models), G2S

715004698 • Grey

\$459.99



LinQ ACCESSORIES WITH 36" BASE

OUTLANDER | RENEGADE

LinQ PREMIUM STORAGE BAG BY OGIO

- Tool-less installation and removal thanks to the LinQ System.
- 17.2 Gal (65 L) capacity semi-rigid cargo bag ideal for carrying anything you need on your vehicle.
- Buckle and elastic closure with a rubber seal that protects dust from entering the bag.
- 3-section lid for partial or full access to your bag.
- Inside separators for optimal bag organization.
- See table for installation location and requirements.

G2 (except 6x6 models), G2L, G2S

715002923 • Black

\$499.99

715003248 • Mossy Oak Break-Up Country Camo

715003248 • Mossy Oak Break-Up Country Camo

\$579.99



Inside separators for optimal bag organization



LinQ ACCESSORIES WITH 36" BASE

LinQ HEAVY-DUTY BASKET

- Made of high-strength, low-alloy steel.
- LinQ mount for easy on, easy off installation.
- Can be placed on both front and back racks of vehicle.
- See table for installation location and requirements.

G2, G2L (front only for MAX & 6x6 models), G2S

715001215

\$269.99



EXPERT CHOICE

Superior build strength and high-walled sides for extra secure load capacity.

LinQ LOW PROFILE BASKET

- Low profile, open basket increases cargo space.
- Perfect for easy access to tools, rope, winch and plow accessories.
- Multiple bungee cord and tie-down anchor points.
- Made of impact-resistant injected polypropylene.
- See table for installation location and requirements.

G2, G2L (front only for MAX & 6x6 models), G2S

715004282

\$209.99



LinQ STORAGE BOX
2 GAL (7.5L)

EASY LOADS IT:
LinQ ACCESSORIES
MOUNT SECURELY
IN SECONDS



GET REMARKABLE VERSATILITY, QUALITY,
AND FIT TO MATCH EVERYTHING YOUR
OUTLANDER 6X6 CAN DO

LinQ ACCESSORIES

OUTLANDER | RENEGADE

New LinQ ANCHOR ADAPTOR KIT

- Allows the installation of accessories with LinQ base of 16" on LinQ racks.
- Tool-less installation and removal.
- For G2S, the LinQ Luggage Rack (715001734) is required for installation.

G2, G2S
715004960
\$77.99



LinQ BASE

- Made of polypropylene glass fiber.
- Allows you to install LinQ accessories.
- Sold in pack of 4.

G2L
715002350
\$28.99



LinQ REPLACEMENT PARTS

- Unique mounting fastener usable on any LinQ System accessory.
- Tool-less installation and removal.
- Sold in pairs.

715001707
\$27.99



SOFT STORAGE BAG

- 3-section bag.
- Transport gear in a weatherproof bag.
- 11.8 Gal (45L) capacity soft cargo bag designed with vehicle's rack in mind to maximize potential storage.
- LinQ Luggage Rack (715001734) is required for G2S.

G2, G2L, G2S
715003759 • Black
\$184.99



STORAGE 2.6 GAL (10L) BAG

- Roll-top dry bag for fully protecting your cargo from the elements.
- Fits in rear compartment of your vehicle.

269502121
\$38.99





OUTLANDER 6X6

LOG BARS

- Log bars allow you to convert the cargo bed into a perfect transport space for 4' (120 cm) timber.
- The driver's safety is guaranteed by the protective front screen.

G2 (6x6 models only)

715001987

\$1 209.99



HARD TOP

- The hard top provides a 116 Gal (440L) cargo box.
- Locking secures your belongings.
- The cover raises assisted by gas cylinders.

G2 (6x6 models only)

715002394

\$1 114.99



OUTLANDER 6X6

TARPAULIN

- Fitted to cover all of the items in your cargo box thoroughly.
- Prevents splash from entering cargo box.
- Easily removable for quick access.

G2 (6x6 models only)

715002416

\$404.99



18 GAL (70L) UTILITY BOX

- Wherever you go and whatever you do, this handy 18 Gal (70L) utility box is your mobile storage.
- The lid keeps your equipment safe from the elements in all conditions.
- Slides under the flatbed with handles for easy access.

G2 (6x6 models only)

715001999

\$559.99



New CARGO BOX POOL

- Transforms the flatbed into a large capacity cargo box for increased loading possibilities.
- Made of durable formed HDPE and shaped to maximize cargo space.
- Allows access to vehicle's water-resistant rear compartment.
- Designed for perfect fit and easy installation.

G2L (6x6 models only)

715005256

\$389.99



TAILGATE EXTENSION/DIVIDER

- The sturdy tailgate extension provides a 10" (25 cm) extension to the cargo space.
- Thanks to the longer cargo bed, even large loads pose no problem.
- With the help of LinQ quick locks, the extension also acts as a solid space divider for the cargo bed.

G2 (6x6 models only)

715002017

\$529.99



CARGO BOX NET

- Solid net designed to hook to the bottom of the cargo box for secure and compact confinement of your cargo.

G2 (6x6 models only)

715001371

\$77.99



TAILGATE LIMITER KIT

- 2 L-shape brackets that hold the tailgate open horizontally.
- Keeps tailgate flush with the rest of the flatbed for longer oversized cargo.

G2 (6x6 models only)

715002080

\$86.99



CAN-AM WINDSHIELDS

Factory-designed wind and debris protection options with clear benefits for every Can-Am ATV rider.

- FIT & COMPATIBILITY**
- QUALITY & RELIABILITY**
- STYLE & VISION**



Tool-less fitment

Install base bracket and quickly remove windscreen when needed



ELEVATED PROTECTION

Pick the windscreen based on the conditions with three different sizes to match your vehicle perfectly.



100% integrated

Perfectly shaped, built and finished to seamlessly improve the way your ATV cuts through the wind.

CREATE YOUR ULTIMATE WIND PROTECTION IN 3 EASY STEPS

1 CHOOSE A DELUXE FAIRING COLOR

DELUXE FAIRING

- Innovative, richly-featured wind protection.
- Quick tool-less removal once base brackets are mounted on handlebar.
- 2 cup holders.
- GPS-mounting-kit-ready.
- Optional mirrors and auxiliary lighting.
- Requires low, high or extra high windshield.
- Tapered Handlebar Adaptor Kit is required for vehicles with 1 1/8" (28 mm) tapered aluminum handlebars.

G2 (except X mr & 6X6), G2L

- 715000935 • Yellow 2000
- 715001231 • Red Viper
- 715001232 • Black

\$254.99

- 715002479 • Light Grey
- 715006125 • Squadron Green **Now**

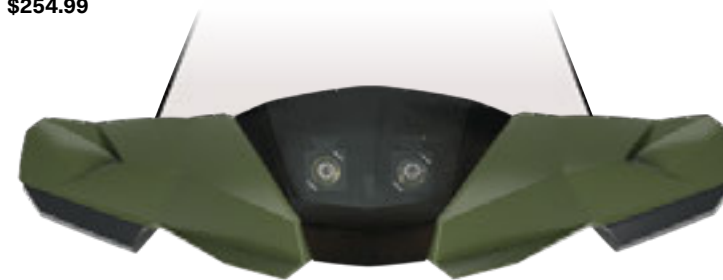

Color-keyed fairings add another dimension to your Outlander's look and performance.

CAMO DECALS FOR BLACK DELUXE FAIRING

- (Not illustrated)
- Camo pattern perfectly matches your camo vehicle.

Deluxe Fairing

- 715002976 • Mossy Oak Break-Up Country Camo
- 715001684 • Next G-1 Vista Camo

\$56.99



715002976

715001683

TAPERED HANDLEBAR ADAPTOR KIT

- (Not illustrated)
- Required to install Deluxe Fairing on an Outlander X-TP and on any vehicle equipped with 1 1/8" (28 mm) tapered aluminum handlebars.

Deluxe Fairing

715002470

\$32.99

2 CHOOSE THE WINDSHIELD HEIGHT ACCORDING TO YOUR RIDING STYLE

EXTRA HIGH WINDSHIELD

- 16" (41 cm) windshield provides the ultimate protection against the elements while touring.
- For wind protection and winter applications.
- Tool-less installation and replacement.

Deluxe Fairing

715000936

\$119.99



16" (41 cm)

HIGH WINDSHIELD

- 11" (28 cm) high, for wind protection and winter applications.
- Tool-less installation and replacement.

Deluxe Fairing

715001211

\$86.99



11" (28 cm)

LOW WINDSHIELD

- 6" (15 cm) windshield allows you to keep your vehicle looking sporty while giving you some protection from the elements and the possibility of enjoying directional lighting.
- Tool-less installation and replacement.

Deluxe Fairing

715001227

\$76.99



6" (15 cm)

3 COMPLETE WITH PERFECTLY INTEGRATED ACCESSORIES

AUXILIARY WINDSHIELD LIGHTING

- 2 premium LED spots for Deluxe Fairing for both increased output and directional lighting.
- 1,800 lumens.
- 2 10W LED Cree light kit.
- Long-range illumination up to 350' (107 m), drawing less than 1 amp per light.

Deluxe Fairing

715003115

\$399.99



DELUXE MIRROR KIT

- Improved mounting system.
- Wide rear view.
- Perfect fit with your Deluxe Fairing and Deluxe Windshield.

Deluxe Fairing

715002353

\$76.99





INTEGRATED AIRFLOW VENT REDUCES AIR TURBULENCE AND ENGINE RUMBLE AT HIGHER SPEEDS FOR LESS BUFFETING AND MORE COMFORT.



OUTLANDER | RENEGADE

WINDSHIELD KITS

- Made of polycarbonate with integrated vent to reduce air turbulence and rumble noise at high speeds for a quieter and smoother ride.
- Quick tool-less removal once base brackets are mounted on handlebar.
- Fits straight and tapered handlebars.
- Improved design for enhanced rigidity

1 EXTRA HIGH WINDSHIELD KIT

- 16" (41 cm) windshield.
- For ultimate wind protection and winter applications.

G2, G2L, G2S (except X mr models)

715003023

\$284.99



16" (41 cm)

2 HIGH WINDSHIELD KIT

- 11" (28 cm) windshield.
- For wind protection and winter applications.

G2, G2L, G2S (except X mr models)

715006382

\$244.99



11" (28 cm)

3 LOW WINDSHIELD KIT

- 6" (15 cm) windshield.
- Allows you to keep your vehicle looking sporty while giving you some protection from the elements.

G2, G2L, G2S (except X mr models)

715003021

\$194.99



6" (15 cm)

OUTLANDER | RENEGADE

HANDLEBAR WIND DEFLECTORS

- Rugged injected plastic construction with Can-Am logo.
- Include removable cap for air flow adjustment.
- Mounting kit sold separately.

G2, G2L, G2S

- 715000525 • Black / Yellow
- 715000537 • White / Black
- 715001706 • Black / Black
- 715000733 • Yellow / Black
- 715003811 • Can-Am Red / Black

- 715003812 • Manta Green / Black
- 715003813 • Orange / Black
- 715003814 • Octane Blue / Black
- 715006117 • Squadron Green/Black **New**
- 715006118 • Viper Red/Black **New**

\$32.99



PASSENGER WIND DEFLECTORS

- These wind deflectors fit on the passenger handles and provide greater comfort while riding.
- Easy to install and remove.

G2 and G2L (MAX models only)

715001669

\$104.99



FULL WRAP ALUMINUM MOUNTING KIT

- Lightweight black die cast aluminum construction.
- Includes complete hardware.
- Handlebar wind deflectors sold separately.

G2, G2L, G2S

715001378

\$104.99



SHORT ALUMINUM MOUNTING KIT

- Lightweight black die cast aluminum construction.
- Includes complete hardware.
- Handlebar wind deflectors sold separately.

G2, G2L, G2S

715001379

\$76.99



MIRROR KIT FOR HANDLEBAR WIND DEFLECTORS

- Do not fit with Full Wrap Aluminum Mounting Kit (715001378).
- Sold in pairs.

Handlebar Wind Deflectors

860200080

\$32.99

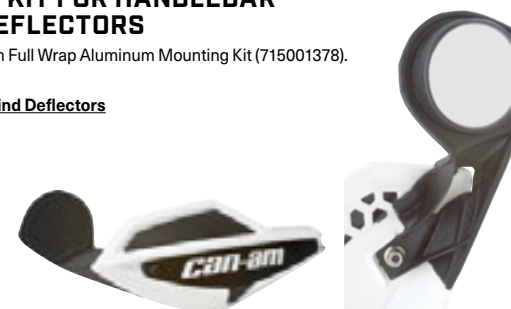

ALUMINUM TAPERED HANDLEBAR

- 7/8" - 1 1/8" (22 mm - 28 mm) tapered handlebar made of 6061-T6 aluminum.
- Includes all hardware, center steering foam and cover.

G2, G2L, G2S

715000550

\$129.99



XT HANDLEBAR PROTECTOR KIT

- Not compatible with Mud Strap (715003053).

G2, G2L

703100352

\$87.99



MIRRORS

- True vision surface 5" x 3" (13 cm x 8 cm).
- Matte finish.
- Stem includes 3/8" (10 mm) thread.
- **Left - 3/8" (10 mm)**
- Bracket (715000190) is required for installation on DS 450.
- Bracket not required for installation on Outlander and Renegade.

709400406

\$30.99

Right - 3/8" (10 mm)

- Bracket (715000190) required except for vehicles with right hand break.

709400523

\$30.99





COMFORTABLE DRIVER & PASSENGER SEATING OPTIONS FOR ALL RIDERS

OUTLANDER

DRIVER BACKREST

- Provides the rider's back with that extra support that makes riding that extra mile way more comfortable.
- Adjusts horizontally to match the driver's height and preference.
- Mounts and locks in firmly onto the vehicle.

G2 (except 6x6 & MAX models)

715003940

\$279.99

G2 2015 & up, G2L (MAX models only, except 6x6 models)

715003942

\$289.99

G2L (except MAX models)

715003941

\$289.99

G2 (6x6 models only, except Max)

715003611

\$269.99



OUTLANDER MAX PASSENGER SEAT KIT

- Perfect to replace used or damaged passenger seat.

G2 2015 and up, G2L (MAX models only)

715002373

\$759.99



AT THE JOBSITE OR ON AN ADVENTURE, LINQ RACKS MAKE IT EASIER TO CARRY THE LOAD

LINQ RACKS & HOLDERS

OUTLANDER | RENEGADE

LinQ RACK EXTENSION

- Fits front or rear.
- Strong and durable.
- Helps keep cargo securely in place.
- Easy and tool-less installation thanks to the LinQ System.
- Anti-corrosion coating with durable powder coat finish.
- LinQ Luggage Rack (715001734) is required for G2S.

G2, G2S

4" [10 CM]

715001711 - Silver 715001665 - Black

\$219.99



6" [15 CM]

715001712 - Silver 715001671 - Black

\$239.99



Twist & Go installation for adding cargo capability in seconds.



OUTLANDER

RACK EXTENSION

- Fits front or rear.
- Made of carbon steel.
- Provides tie-down points to secure cargo on racks.
- Easy installation on tubular rack.
- Anti-corrosion coating with durable powder coat finish.

G2L

5" [13 CM]

715001913
\$134.99



8" [20 CM]

715001914
\$154.99



EXPERT CHOICE

Durable extensions with multiple attachment points and work-ready finish.

RENEGADE

REAR ALUMINUM RACK

- 30 lb (14 kg) capacity.
- Compact, lightweight aluminum construction.
- Engraved Can-Am logo.
- Stamped 5052 aluminum center plate.
- Easy to install.

G2S

715001360
\$254.99



LinQ LUGGAGE RACK

- Bolt-on rack.
- Enables use of LinQ mounted accessories on the G2S.

G2S

(except X mr models)
715001734
\$314.99



OUTLANDER

GUN BOOT RACK

- Made of steel.
- Designed for the tubular rack.
- For use with Gun Boot 6.0 Impact by Kolpin.
- Can be mounted to either side of the vehicle.

G2L (except MAX models)

715001918
\$149.99

G2L (MAX models only)

715001919
\$149.99



LinQ GUN BOOT RACK

(Not illustrated)

- This lightweight Gun Boot Rack can be mounted on either side of your Outlander using the tool-less LinQ System.
- For use with Gun Boot 6.0 Impact by Kolpin.

G2 (except MAX, 6X6 & X mr 1000)

715002112 • Black
\$179.99

G2 (MAX & X mr 1000 models only)

715002113 • Black
\$158.99

GUN BOOT 6.0 IMPACT⁺ BY KOLPIN⁺

- Extra room for pistol-grip-type weapons and small bipods.
- Easily fits firearms up to 51" (130 cm) in total length.
- Provides ample room for 2 3/8" (60 mm) scopes.
- Hatchback design allows easy access.
- Ergonomically designed handle and molded attachment points for sling.

G2, G2L

715001419
\$87.99



- Snap-close cover with locking capability.
- Designed to accommodate left and right hand bolt-action rifles and shotguns.
- Includes removable, shock absorbing foam and nylon Impact liner for superior interior protection.
- Requires appropriate mounting kit for installation.

MULTI-FIT HOLDER

- Open U-shaped bracket for carrying tools (shovel, axe) and hunting weapons (rifle, bow) that are safely secured, but easily accessible.
- Easy installation on tubular rack, extension racks, basket or bumpers.
- For G2, the LinQ Rack Extension (715001711) is required.
- Sold in pairs.

G2, G2L

Single	Double
715002354	715001945
\$61.99	\$81.99



OUTLANDER | RENEGADE

GEAR GRIPS BY KOLPIN

- Durable, flexible grips cushion and protect while providing a custom fit for a variety of items from 1" to 4" (2.5 cm to 10 cm) in diameter.
- Heavy-duty design for carrying bows, fishing poles, rakes, farm tools and more.
- Quick-release button opens grip quickly for easy access to gear.
- Heavy-duty base system built for the toughest adventures.
- Easy installation on tubular racks, extension racks, brackets or bumpers.
- Sold in pairs.

G2L

715001421
\$87.99



LinQ MOUNTED GEAR GRIPS BY KOLPIN

(Not illustrated)

- Same features as Gear Grip by Kolpin (715001421).
- Make transporting your tools a snap by combining the Gear Grips with the LinQ System.
- 360° orientation.
- LinQ Luggage Rack (715001734) is required for G2S.

G2, G2S

715001351
\$134.99

LinQ TOOL HOLDER

- Ultra-versatile tool holder.
- Convenient swivel-latch allows tools to be stored in any orientation.
- LinQ Luggage Rack (715001734) is required for G2S.
- Sold in pairs.

G2, G2S, G2L

715003059
\$61.99



OUTLANDER | RENEGADE

HMWPE SKID PLATES

Our Plastic Plates glide smoothly and silently over obstacles, offering great protection in rough terrain. Made of 1/4" (6 mm) thick abrasion-resistant thermoformed High Molecular Weight Polyethylene (HMWPE).

- ✓ Lighter than aluminum
- ✓ Superior stress crack resistance
- ✓ High impact strength



715004806



Offer your Outlander or Renegade the full protection kit or get them individually	G2						G2L		G2S	
	2016 & PRIOR		2017-2018		2019 & UP		Except MAX models	MAX models only	2017-2018 MODELS	2019 & UP
	Except MAX & X mr 1000R models	MAX & X mr 1000R models only	Except MAX & X mr 1000R models	MAX & X mr 1000R models only	Except MAX & X mr 1000R models	MAX & X mr 1000R models only				
HMWPE SKID PLATE PROTECTION KIT	715004214 \$819.97	715004215 \$849.97	715004209 \$824.97	715004210 \$854.97	715004806 \$824.97	715004807 \$854.97	715004211 \$824.97	715004212 \$854.97	715004213 \$824.97	715004809 \$824.97

INDIVIDUAL HMWPE SKID PLATES										
① A-ARM PROTECTORS	715002924 \$139.99	715002924 \$139.99	715002924 \$139.99	715002924 \$139.99	715004822 \$139.99	715004822 \$139.99	715002924 \$139.99	715002924 \$139.99	715002924 \$139.99	715004822 \$139.99
② UNDERBELLY PLATES	715002926 \$544.99	715002927 \$574.99	715002926 \$544.99	715002927 \$574.99	715002926 \$544.99	715002927 \$574.99	715002928 \$544.99	715002929 \$574.99	715002974 \$544.99	715002974 \$544.99
③ TRAILING ARM PROTECTORS	715002925 \$134.99	715002925 \$134.99	715003466 \$139.99	715003466 \$139.99	715004823 \$139.99	715004823 \$139.99	715003466 \$139.99	715003466 \$139.99	715003466 \$139.99	715004823 \$139.99

OUTLANDER

ALUMINUM SKID PLATES

For ultimate durability and strength, all our Aluminum Skid Plates are made with High Strength 5052 H32 Aluminum 3/16" (4.5 mm) thick.

- ✓ Ultimate durability
- ✓ High strength



715004197

Offer your Outlander the full protection kit or get them individually	G2						G2L	
	2016 & PRIOR		2017-2018		2019 & UP		ANY YEAR	
	Except MAX & X mr 1000R models	MAX & X mr 1000R models only	Except MAX & X mr 1000R models	MAX & X mr 1000R models only	Except MAX & X mr 1000R models	MAX & X mr 1000R models only	Except MAX models	MAX models only
HMWPE SKID PLATE PROTECTION KIT	715002137 \$831.93	715002138 \$863.93	715004197 \$836.93	715004198 \$868.93	New 715004804 \$851.93	New 715004805 \$883.93	715004199 \$874.93	715004200 \$906.93

INDIVIDUAL ALUMINUM SKID PLATES								
① A-ARM PROTECTORS	715001667 \$154.99	715001667 \$154.99	715001667 \$154.99	715001667 \$154.99	New 715004820 \$159.99	New 715004820 \$159.99	715001667 \$154.99	715001667 \$154.99
② FRONT SKID PLATE	715000926 \$86.99	715000926 \$86.99	715000926 \$86.99	715000926 \$86.99	715000926 \$86.99	715000926 \$86.99	715001906 \$124.99	715001906 \$124.99
③ CENTRAL SKID PLATE	715002078 \$119.99	715002078 \$119.99	715002078 \$119.99	715002078 \$119.99	715002078 \$119.99	715002078 \$119.99	715002078 \$119.99	715002078 \$119.99
④ FOOTWELL PROTECTOR PLATES	715000922 \$159.99	715000922 \$159.99	715000922 \$159.99	715000922 \$159.99	715000922 \$159.99	715000922 \$159.99	715000922 \$159.99	715000922 \$159.99
⑤ TRAILING ARM PROTECTORS	715001129 \$134.99	715001129 \$134.99	715003741 \$139.99	715003741 \$139.99	New 715004821 \$149.99	New 715004821 \$149.99	715003741 \$139.99	715003741 \$139.99
⑥ REAR DIFFERENTIAL PROTECTORS	715000920 \$76.99	715000920 \$76.99	715000920 \$76.99	715000920 \$76.99	715000920 \$76.99	715000920 \$76.99	715000920 \$76.99	715000920 \$76.99
⑦ REAR SKID PLATE	715002028 \$97.99	715002029 \$129.99	715002028 \$97.99	715002029 \$129.99	715002028 \$97.99	715002029 \$129.99	715002028 \$97.99	715002029 \$129.99

RENEGADE

ALUMINUM SKID PLATES

For ultimate durability and strength, all our Aluminum Skid Plates are made with High Strength 5052 H32 Aluminum 3/16" (4.5 mm) thick.

- ✓ Ultimate durability
- ✓ High strength



715004201



Offer your Renegade the full protection kit or get them individually	G2S		
	2016 & PRIOR	2017-2018	2019 & UP
ALUMINUM SKID PLATE PROTECTION KIT <small>NOT COMPATIBLE ON X MR MODELS</small>	715002139 \$861.93	715004201 \$866.93	<small>New</small> 715004808 \$881.93
INDIVIDUAL ALUMINUM SKID PLATES			
① A-ARM PROTECTORS	715001667 \$154.99	715001667 \$154.99	<small>New</small> 715004820 \$159.99
② FRONT SKID PLATE	715000925 \$86.99	715000925 \$86.99	715000925 \$86.99
③ CENTRAL SKID PLATE	715002078 \$119.99	715002078 \$119.99	715002078 \$119.99
④ FOOTWELL PROTECTOR PLATES <small>NOT COMPATIBLE ON X MR MODELS</small>	715001359 \$189.99	715001359 \$189.99	715001359 \$189.99
⑤ TRAILING ARM PROTECTORS	715001129 \$134.99	715003741 \$139.99	<small>New</small> 715004821 \$149.99
⑥ REAR DIFFERENTIAL PROTECTORS	715000920 \$76.99	715000920 \$76.99	715000920 \$76.99
⑦ REAR SKID PLATE	715002028 \$97.99	715002028 \$97.99	715002028 \$97.99

OUTLANDER 6X6

HMWPE & ALUMINUM SKID PLATES

Our Plastic and Aluminum Plates glide smoothly and silently over obstacles, offering great protection in rough terrain.

HMWPE

Made of 1/4" (6 mm) thick abrasion-resistant thermoformed High Molecular Weight Polyethylene (HMWPE).

- ✓ Lighter than aluminum
- ✓ Superior stress crack resistance
- ✓ High impact strength

ALUMINUM

Made with High Strength 5052 H32 Aluminum 3/16" (4.5 mm) thick.

- ✓ Ultimate durability
- ✓ High strength



Offer your Outlander 6x6 a full protection solution by combining our skid plates or get them individually.

Offer your Outlander 6x6 a full protection solution by combining our skid plates or get them individually.	G2 6X6			G2L 6X6
	2016 & PRIOR	2017 - 2018	2019 & UP	ANY YEAR
INDIVIDUAL HMWPE SKID PLATES				
① HMWPE A-ARM PROTECTORS	715002924 \$139.99	715002924 \$139.99	715004822 \$139.99	715002924 \$139.99
② HDPE FULL UNDERBELLY SKID PLATE	715003646 \$659.99 (Except MAX) 715003647 \$629.99 (MAX only)	715003646 \$659.99 (Except MAX) 715003647 \$629.99 (MAX only)	715003646 \$659.99 (Except MAX) 715003647 \$629.99 (MAX only)	715005259 \$829.99 (MAX only)
③ HMWPE TRAILING ARM PROTECTORS	715002925 \$134.99	715003466 \$139.99	715004823 \$139.99	715003466 \$139.99
INDIVIDUAL ALUMINUM SKID PLATES				
① ALUMINUM A-ARM PROTECTORS	715001667 \$154.99	715001667 \$154.99	<small>New</small> 715004820 \$159.99	715001667 \$154.99
② ALUMINUM FULL UNDERBELLY SKID PLATE	—	—	—	—
③ ALUMINUM TRAILING ARM PROTECTORS	715001129 \$134.99	715003741 \$139.99	<small>New</small> 715004821 \$149.99	715003741 \$139.99

CAN-AM BUMPERS

The strength to endure and the character to wear well—our bumpers are ready for it.



FIT & COMPATIBILITY



QUALITY & RELIABILITY



STYLE & VISION

HEAVY-DUTY LOOKS

Real capability—with a durable fit and finish you'll just have to age yourself



DURABILITY SLEEK ENOUGH TO WORK ALONGSIDE YOUR HERD

COMPLETE RANCHER PROTECTION KIT

See p. 34



100%
integrated

Designed to seamlessly integrate with the style, fit, finish, and capability of your ATV.



Durable textured finish

For long life and better resistance to scratches and corrosion.



OUTLANDER

XT BUMPERS

- Provide additional protection against obstacles.
- Tough and durable, can be added on base Outlander model to convert vehicle into XT model.

- Standard on XT model.
- Large tube construction with textured black finish and metal corners.

XT FRONT BUMPER

G2
715004837
\$214.99



XT REAR BUMPER

G2
715004920
\$214.99



- Large tube construction.
- Protects vehicle frame against obstacles.

XT FRONT BUMPER

• Winch compatible.
G2L
715001910
\$174.99



XT REAR BUMPER

G2L
715001911
\$134.99





RANCHER REAR BUMPER

WORK AND MOVE CONFIDENTLY WITH HEAVY-DUTY, HERD-FRIENDLY PROTECTION OPTIONS



RANCHER FRONT BUMPER

OUTLANDER

COMPLETE RANCHER PROTECTION KIT

- These heavy-duty bumpers and fender guard are designed to pull double duty: protect your ATV and anything it comes in contact with, while also enhancing the look of your ATV.
- Made tough and designed to deliver a rugged appearance, together they offer front, rear and full side protection for farmer, rancher and forestry applications.
- Requires Body Side Protector Extensions (715003460) for installation on MAX models.

This kit includes:

- Rancher Front Bumper (715003461)
- Rancher Rear Bumper (715003462)
- Body Side Protector (715003459)

G2, G2L (except X mr & 6x6 models)

715003463
\$1,034.97

RANCHER FRONT BUMPER

- The low front end protection and plates allow you to use your ATV within cattle herds and guard the safety of both the vehicle and the animals.
- The flat front portion facilitates gently prodding cattle or pushing light objects, e.g. closing a fence.

G2, G2L (except X mr models)
715003461
\$349.99



- The full frontage coverage extends to provide an extra layer of defense to your headlights and radiator.
- Inside and outside anti-corrosion coating with durable powder coat finish.
- Not compatible with track systems, plows and front hitch.

RANCHER REAR BUMPER

- Ideal for using your ATV within cattle herds and guard the safety of both the vehicle and the animals.
- Coverage extends to provide an extra layer of defense to your tail lights.
- Inside and outside anti-corrosion coating with durable powder coat finish.
- Not compatible with track systems.

G2, G2L (except 6x6 models)

715003462
\$299.99



OUTLANDER

BODY SIDE PROTECTOR

- The heavy-duty fender guard designed to pull double duty: protecting your ATV and also enhancing the look of your ATV.
- Made tough and designed to deliver a rugged appearance, this fender guard offers full side protection for farmer, rancher and forestry applications.
- Built of durably bold 1.25" (3 cm) diameter steel-tube construction, with inside and outside anti-corrosion coating with durable powder coat finish.
- Not compatible with Self Clearing Footwell.
- XT Front and Rear Bumpers or Rancher Front and Rear Bumpers are required for installation.
- Requires Body Side Protector Extensions (715003460) for installation on MAX models.

G2, G2L, with Rancher bumpers (except X mr & 6x6 models)

715003459
\$384.99

G2L with XT bumpers (except X mr & 6x6 models)

715003614
\$419.99

G2 with XT bumpers (except 6x6 models)

715004940
\$394.99



BODY SIDE PROTECTOR EXTENSIONS

- (Not illustrated)
- This specially designed extension for the Body Side Protector is made specifically to fit and seamlessly integrate the look of Outlander MAX models.

G2, G2L (MAX models only)
715003460
\$78.99

EXTREME FRONT BUMPER

- Ultra-sturdy build.
- Enhances front-vehicle protection.
- Compatible with XT Front Bumper.
- Fits the Apache™ 360 Track System (when side panels are removed).

G2	G2L
• Not compatible with Front Hitch.	715004279
715001286	\$289.99
\$314.99	



715001286



715004279

OUTLANDER 6X6

New FLATBED PROTECTION TUBES

- Bolt-on bumpers for the sides of the 6x6 flatbed.
- Protect the exterior plastic components of the flatbed from rocks, trees and other obstacles when traversing enclosed areas or loading cargo onto the bed.

G2L 6x6	G2 (6x6 models only)
715005266	715002030
\$374.99	\$529.99



715005266



715002030

RENEGADE

RENEGADE EXTREME FRONT BUMPER

- Enhanced vehicle front protection.
- Required as a mounting point for Radiator Relocator (715001929).

G2S
715002469
\$279.99



OUTLANDER

FENDER FLARES

- Kit designed to deliver extra protection from dirt and debris, therefore a must if you enjoy riding in the mud.
- Made of injected plastic that hugs your vehicle fenders perfectly.
- Gives vehicle added flair for that rugged cool look.
- Includes front and rear extensions and all mounting hardware.

G2 (except with 30" tires) (except 6x6 models)	G2L	G2L European vehicles only 2015 & up
715001764	• Not compatible with European vehicles	715004487
G2 (with 30" tires) (except 6x6 models)	715001909	715004487
• Standard on G2 X mr 1000R.	\$169.99	\$169.99
715004250		
\$169.99		



FENDER FLARE EXTENSIONS

- Block terrain debris from kicking up onto you as you ride or damaging your vehicle thanks to these extra-large Fender Flare Extensions, which also include mud flaps for added protection from mud/snow, especially when riding with track kits.
- Made of High Molecular Weight Polyethylene (HMWPE) for advanced abrasion resistance.
- Include front and rear extensions.

G2 (except 6x6 models)	G2L
• Must be used with Fender Flare for G2 (715001764).	• Must be used with Fender Flare for G2L (715001909).
715005111	715003615
\$259.99	\$259.99



RENEGADE

FENDER FLARES

- Integrated extended Fender Flares for sporty look and full body protection from dirt and water.
- Include front and rear extensions and all mounting hardware.

G2S (except X mr models)
705012695
\$261.99



OUTLANDER | RENEGADE

HEATED GRIPS & THUMB THROTTLE COMBO

- Not compatible with Intelligent Throttle Control (iTC).

G2, G2L, G2S (except 2020 models equipped with 850 engine and 2019 & up models with 1000R engine, 6x6 models and T Category models)
715003250
\$284.99

- Compatible with Intelligent Throttle Control (iTC).

G2, G2L, G2S (2020 models equipped with 850 engine and 2019 & up models with 1000R engine, 6x6 models and T Category models)
715004815
\$284.99



EXPERT CHOICE

Heat, where you want it. This popular upgrade takes the chill from cold, wet rides.

① LED dimmer facilitates reading temperature settings.

② 4 temperature settings with individual controls for thumb and grips. Returns to previous heat setting.

③ One-touch shutdown.

Wiring Cable (710004567) is required for installation on G2 and G2L.

WIRING CABLE

- (Not illustrated)
- Required for installation of Heated Hand Grips & Throttle Combo.

G2L
710004567
\$13.49

HEATED VISOR OUTLET

- Strategically positioned on vehicle to maintain your agility.
- Optional visor outlet that delivers fog-free riding.
- Quick and easy installation.
- Sold individually.
- Heated Visor not included.

G2, G2L
715001246
\$66.99



OUTLANDER

HEATED PASSENGER GRIPS & VISOR OUTLET

- Replace your stock passenger handles.
- Dual temperature switch integrated into seat arm for 3-zone heated handles and grips.
- Heated visor outlet integrated into seat arm.

G2, G2L (MAX models only)
715001926
\$264.99
G2 (2013-2014) (MAX models only)
715002116
\$249.99



OUTLANDER | RENEGADE

New ELECTRONIC DEVICE HOLDER

- Robust injected-polypropylene construction allows for the right fit and easy installation.
- Adjustable unit safely holds smartphones or small tablets with a length or width measuring between 2.9" (7.5 cm) and 5.1" (13.0 cm) with or without protective case.
- Integrated storage (0.6 Gal / 2.1L).
- Guiding wire grooves to pass charging cable through the lid.
- Possibility of relocating 12V power outlet or installing USB outlet in storage compartment (USB power outlet sold separately).
- Not compatible with windshields and Snorkel Kit.

G2, G2L (except 6x6 & X mr models)

715004919

\$154.99



Integrated storage with access to the dash 12V outlet for device charging

CGX3 CAMERA

- 160° wide angle lens.
- Resolution options: From 3MP up to 20MP and VGA.
- Video resolutions available: 2.7K at 30 frames per second (FPS), 720P at 120/60/30 FPS, 1080P at 60/30 FPS and VGA at 240 FPS.
- Record videos in 4K UHD at 24 FPS, 2.7K QHD at 30 FPS and 720P at 120 FPS.
- Memory: Class 10 32GB Micro SD card.
- 2" (5 cm) capacitive touchscreen.

9700130090

\$399.99

- Li-ion battery capacity of 1050mAh, working time of 1/1.5 hours and charging time of 3 hours (2 batteries included).
- WiFi function remotely operates up to 33-49 ft (10-15 meters) with mobile devices and Cyclops app for Android and iOS.
- Waterproof up to 33 ft (10 meters) without a case.
- Features modes such as invert, time lapse, high speed and loop recording, motion detection, capture (while recording a video), burst and anti-sharing.
- Comes with 8 mounting accessories.



CGX3 GIMBAL CAMERA STABILIZER

(Not illustrated)

- 3-axis full 360-degrees precision: Eliminates shaky video and allows you to easily shoot pro-quality, cinematic-like footage with your Action Camera.
- Built-in Bluetooth 4.0.
- Independent APP to control the gimbal.

9700160090

\$349.99

- Compatible with iOS 8.0 and Android 4.4 or above.
- Rechargeable battery.
- Rugged, full aluminum alloy.
- 5-way joystick and multi-function button for flexible operations and convenient switch.

CGX3 POWER STICK MOUNT

(Not illustrated)

- 5200mAh of continuous power in your hand, when you need it.
- Rubberized silicone handle for comfort and grip.
- Power indicator light to let the user know when the battery is running low.
- Includes power hand grip, long screw, convert tripod mount, phone clip mount, USB mini cord, USB micro cord and adjustable strap.

9700100090

\$54.99

CGX3 LED LIGHT

(Not illustrated)

- Wide-Angle 300 Lumen Max. (5500K-6000K) by 3 LEDs.
- Waterproof, attachable light.
- Three modes of light: High, Low, Flashing.
- Rechargeable battery: 1050mAh.

9700200090

\$59.99

CGX3 SELFIE STICK

(Not illustrated)

- Easily take photos or record videos with the CGX3 Selfie Stick.
- This selfie stick is made tough for any sport or activity.

9700170090

\$24.99

BLUETOOTH HANDLEBAR SOUNDBAR BY MTX

- Bluetooth speaker with the unbeatable convenience of fingertip control.
- Rugged IP66-rated weather-resistant speaker designed for outdoor use.
- Driven by 150 watts of quality audio power.
- Seamless integration and operation from Bluetooth enabled devices.
- Includes input, ground and ignition wires, plus auxiliary port and 3.5" (8.89 cm) connector cable.
- Not compatible with XT Handlebar Protector Kit.

Note: We recommend you use 320 Kbps MP3 - 192-256 Kbps AAC or AIFF, WAV formats to match the potential of the speaker. More compressed formats will probably have degraded sound quality.

G2, G2L, G2S

219400840

\$529.99



USB POWER OUTLET KIT

- Recharges your electronic devices while riding* (smartphone, MP3, heating gear, etc.).
- Dual port USB connectors.
- *The power outlet is not capable of recharging all device types while riding.

G2, G2L, G2S

219400510

\$37.99



MULTI POSITION LIGHT MOUNT KIT

- Multi-position plastic clamps that fit on various tubing sizes: 0.75" to 1.5" (19 mm to 38 mm).
- Required for the installation of the 2" (5 cm) Square LED Lights (2 x 10W).
- Kit includes tube clamp mounts and power cables.

G2 (except X xc), G2L, G2S

715004274

\$104.99



OUTLANDER

BAJA DESIGNS HIGH BEAM KIT

- Thanks to their direct bolt-on and plug-and-play installation right into the original high beam location, upgrading from your stock high beam lights to these powerful Baja Designs Squadron Pro LED Lights becomes child's play.
- Each spot is equipped with 4 Cree LEDs producing 4,900 lumens at 40 watts.
- Driving/Combo light pattern for smooth blend of light for both near field applications and distance.

G2

715004284

\$769.99



EXPERT CHOICE

Plug-and-play lighting upgrade gives eye-opening visibility, anywhere.

OUTLANDER | RENEGADE

2" [5 CM] SQUARE LED LIGHTS (2 X 10 WATTS)

- 2 x 900 lumens 10W LED Cree light kit.
- Long-range illumination up to 350' (107 m), drawing less than 1 amp per light.
- Multi-Position Light Mount Kit is required for installation.
- Not EC compliant.

G2 (except X xc), G2L, G2S

715004293

\$204.99



RAM' LED SPOTLIGHT

- 540 lumens LED light (9 Watt) heavy-duty spotlight standard-equipped with 1" (2.5 cm) diameter rubber-coated double ball and socket system.

G2, G2L, G2S

710005423

\$149.99



AUXILIARY WINDSHIELD LIGHTING

- 2 premium LED spots for Deluxe Fairing for both increased output and directional lighting.
- 1,800 lumens.
- 2 x 10W LED Cree light kit.
- Long-range illumination up to 350' (107 m), drawing less than 1 amp per light.

Deluxe Fairing

715003115

\$399.99



CENTER CONSOLE DAY LIGHT

- Mountable on top end of center console.
- Enhances look of vehicle.

G2S (except X mr)

715000691

\$76.99



OUTLANDER | RENEGADE

BATTERY CHARGER/MAINTAINER

- Fully automatic 3 amp battery charger / maintainer.
- Keeps stored lead-acid batteries charged.
- Charges and maintains small batteries.
- Microprocessor controlled multi-stage charging for added precision, safety and battery life.
- Automatically detects 6 or 12 volt batteries.
- Float mode monitoring automatically maintains optimum battery charge.
- Reverse hook-up protection helps protect battery and charger from damage.
- Hook attachment hangs outside the work area for safety and convenience.
- Press the display button to show the charge progress.
- Energy efficient/eco friendly, meets the highest industry standards for energy efficiency.
- Content: 3 amp battery charger, clamp adapter, DC adapter, 24" (61 cm) fused ring leads harness with weather cap, owner's manual.

715005061

\$71.99

EXPERT CHOICE

Keep your batteries charged and ready to go, automatically and efficiently.

JUMP STARTER

- IPX3 water-resistant and enclosed output ports.
- 4 LED battery indicators for easy read on battery charge level.
- Compact design, will conveniently fit in your backpack, glove box or any other storage compartment.
- Quickly starts vehicles in emergencies.
- Great for powersport vehicles, motorcycles and 4 and 6 cylinder vehicles.
- 2.4A + 1A/5V USB ports for fast charging of all USB devices, including smartphones, MP3 players and tablets.
- Smart cable provides protection against reverse polarity, short circuit, low voltage, high temperature and reverse charging.
- Built-in LED light (3 modes).
- Content: 300CA jump starter, SA858 smart cable clamp, MC-USB to USB charging cable, travel bag, user manual.

715005062

\$149.99

QUICK CONNECT BATTERY CABLE

- Quickly and easily connect and charge different items with your charger.
- Included in the Battery Charger/Maintainer (715005061).
- Sold individually.

715005408

\$10.49

New QUICK CONNECT CABLE WITH BATTERY INDICATOR

- Quickly and easily connect and charge different batteries with your charger.
- 3-color LED indicator provides constant battery health indication.
- Sold individually.

715006055

\$25.99

GARMIN⁺ MONTANA⁺ 680T GPS

- Rugged and waterproof, the Montana 680T is element-proof.
- 4" (10.2 cm) dual-orientation, sunlight-readable touchscreen and glove-friendly touchscreen display, to give you vivid colors and high-resolution images.
- 8-megapixel autofocus camera automatically geotags photos.
- Tracks both GPS and GLONASS satellites for improved positioning and typically faster fixes.
- Preloaded TOPO maps, plus 1-year BirdsEye Satellite Imagery subscription.
- 3-axis compass with barometric altimeter.
- Specific GPS cradle included (vehicle mounting kit required).
- Includes a preloaded map for US.

G2, G2L, G2S

European Version

715002830

• EC compliant.

\$789.99

• Includes preloaded European recreation maps.

715003456



GPS RAM MOUNT FOR HANDLEBAR

- Convenient bracket for installing the Garmin Montana GPS (not included) onto your unit's handlebar.

G2, G2L

715001985

\$71.99

CANADIAN MAP FOR GARMIN MONTANA 680T GPS

- Additional and readily-programmable Canadian basemap for Garmin Montana 680T GPS system.
- Requires Garmin Montana 680T GPS (715002830).

710005065

\$194.99

OUTLANDER | RENEGADE

WARN⁺ VRX

- Extreme IP68-rated waterproof sealing keeps the elements out.
- Durable all-metal construction.
- Black powder-coated finish and stainless steel fasteners for corrosion resistance.
- Robust new clutch design based on 70+ years of WARN 4WD hub lock know-how.

- Load-holding brake for great control.
- Smooth and reliable all-metal three-stage planetary gear train.
- Dash-mounted rocker control and corded remote.
- Limited lifetime warranty (mechanical), 3-year warranty (electrical).

New WARN VRX 25

- Pulling strength capability of 2,500 lb (1,134 kg).
- 50 ft. of 3/16" (15 m of 4.8 mm) wire steel cable.
- Cast aluminum fairlead.

G2, G2L, G2S

715006107

\$554.99

New WARN VRX 35

- Pulling strength capability of 3,500 lb (1 588 kg).
- 50 ft. of 3/16" (15 m of 4.8 mm) wire steel cable.
- Cast aluminum fairlead.

G2, G2L, G2S

715006108

\$609.99

New WARN VRX 35-S

- Pulling strength capability of 3,500 lb (1 588 kg).
- 50 ft. of 1/4" (15 m of 6.3 mm) synthetic rope.
- Cast aluminum fairlead.

G2, G2L, G2S

715006109

\$739.99

OUTLANDER

CAN-AM HD

- Heavy-duty 4-way roller fairlead.
- Ergonomic clutch handle.
- Rugged all-steel gears and bushings provide more torque and longer life.
- Automatic 100% load-holding brake.

- Sealed solenoid for all-weather protection.
- Wired Remote Control sold separately.
- Weather sealed handlebar mounted switch.
- EC compliant.

New CAN-AM HD 2500 WINCH

- Pulling strength capability of 2,500 lb (1,134 kg).
- 50 ft. of 3/16" (15.2 m of 4.8 mm) wire steel cable.

G2, G2L

715006414

\$339.99

New CAN-AM HD 3500 WINCH

- Pulling strength capability of 3,500 lb (1,588 kg).
- 50 ft. of 7/32" (15.2 m of 5.5 mm) wire steel cable.

G2, G2L

715006415

\$379.99

OUTLANDER 6X6

REAR WINCH KIT

- The remote-controlled rear winch is a godsend when you want to pull yourself out of a tough spot or move heavy loads.
- Includes a fully-sealed Warn winch and all wiring and hardware needed for an easy and quick installation.
- Pulling strength capability of 3,000 lb (1,361 kg).
- 50 ft. of 3/16" (15.2 m of 4.8 mm) wire steel cable.

G2 (6x6 models only)

715002484

\$1,234.99

OUTLANDER | RENEGADE**WARN HAWSE FAIRLEAD**

- Double-powder-coated construction.
- Required to use the Synthetic Winch Cable (715004254) on Warn winches.
- To be used with synthetic winch cables only.

Warn winches
715004255
\$87.99

**WINCH MOUNTING PLATE**

- Adds functionality to your Renegade.
- Fits Can-Am winches by Warn.

G2S
715000927
\$139.99

**WINCH ACCESSORIES KIT**

- Get the most out of your winch.
- Double your pulling power, change your pulling direction and keep your winch in proper working order.
- Includes tree straps, snatch block, shackle and winching gloves.

715002409
\$124.99

**WIRELESS REMOTE CONTROL**

- The system is quick and easy to install, thanks to a wiring harness with an integrated antenna and all necessary mounting hardware.
- The system allows you to operate your winch from anywhere within a 50' (15.2 m) radius, increasing your recovery options.
- All components are weatherproof.

Warn winches
715002542
\$239.99

**WIRED REMOTE CONTROL**

- This kit allows winch owners to add the hand-held remote to their winch.
- EC compliant.

For ATVs with handlebar winch remote socket
710002270
\$52.99

ATVs without the winch remote socket
• Side panel Remote Socket (715003651) is required.

710001002
\$76.99

Can-Am HD winches
710004887
\$41.99

**ROLLER FAIRLEAD**

- Features top, bottom and side rollers for less cable wear and smoother operation from any direction for easier winching.

715000011 • **Warn winches**
\$71.99
705204571 - **Can-Am HD winch**
\$45.99

**HOOK WITH SAFETY LATCH & STRAP KIT**

- Heavy-duty winch-rope hook with stainless steel snap.
- Includes a nylon safety strap.

Can-Am HD winches
705014949
\$25.99

**REPLACEMENT WIRE ROPE**

- Play it safe, always carry a replacement wire rope.
- 3,500 lb (1,588 kg) pulling strength.

Can-Am HD 2500
• 50 ft. of 3/16" (15.2 m of 4.8 mm) wire rope.
705014983
\$23.49

ATV Warn winches
• 50 ft. of 7/32" (15.2 m of 5.5 mm) wire rope.
705009321
\$40.99

ATV Warn winches
• 50 ft. (15.2 m) aircraft grade steel wire.
• 7/32" (5.5 mm) diameter.
715006256
\$81.99

**SYNTHETIC WINCH CABLE**

- Easier to manipulate than steel cable.
- Replaces the original cable on any factory installed Warn winch or sold as an accessory by BRP.
- Kit includes synthetic rope and rock guard sleeve.
- Always use with new Hawse Fairlead (715004255).
- 50 ft. (15.2 m).
- 3,500 lb (1,588 kg) pulling strength.

ATV Warn winches
715004254
\$154.99

**WARN REMOTE SOCKET**

(Not illustrated)
• Winch remote socket, located on side panel, is required for wired remote control.
715003651
\$31.99

WINCH WIRE HARNESS

(Not illustrated)
• Required plug-and-go wiring to install Warn winch only.
• Not required for Can-Am HD winches.
G2L
715002453
\$50.99

HARDWARE ADAPTER KIT

(Not illustrated)
• Required to install Warn Winch Kit (715006107, 715006108, 715006109) on 2016 and up models.
• Required to install Can-Am HD 2500 Winch (715006414) and Can-Am HD 3500 Winch (715006415) on G2L 2017 and up models.
715003477
\$49.99

ADD TOWING CAPACITY
FOR ALL YOUR
UTILITY HARD WORK

**OUTLANDER | RENEGADE****FRONT & REAR HITCH DRAWBAR**

- Standard on 2" (5 cm) receiver hitch.
- It offers 1,500 lb (680 kg) of towing capacity.
- Hitch ball not included.

G2, G2L, G2S
715000972
\$91.99

European Version
• Drawbar with 2" (5 cm) hitch ball.
705208131 (T Homologated)

**RUBBER RECEIVER PLUG**

- Rubber cap for 2" (5 cm) hitch receiver.

705204503
\$14.99

**REAR HITCH**

- E-coat finish.
- Fixed hitch ball mounting bracket.
- Provides fixed mounting point for trailer ball to provide vehicle with towing capabilities.
- This hitch offers 1,500 lb (590 kg) of towing capacity.
- Hitch ball not included.

G2, G2L, G2S (except 6x6 models)
715001925
\$66.99

**REAR RECEIVER HITCH**

- E-coat finish.
- Does not affect ground clearance.
- Trailer ball not included.
- On 4X4 use, this hitch offers 1,654 lb (680 kg) of towing capacity.
- On 6X6 use, this hitch offers 1654 lb (750 kg) of towing capacity.
- Compliant with European T regulations.
- Not compatible with rear bumpers and G2L models.

G2S 2012 with 800R or 1000 engines, G2S 2013 & up, G2L & G2
715005186
\$116.99

**OUTLANDER****FRONT RECEIVER HITCH**

- Front receiver hitch for Outlander with or without a winch.
- This hitch offers 1,500 lb (590 kg) of towing capacity.
- Allows you to maneuver your trailer easily in tight, confined areas.
- Hitch bar sold separately.
- Not compatible with Extreme Front Bumper, Rancher Bumper and ProMount Plows.

G2
715000921
\$104.99



OUTLANDER

OUTLANDER RADIATOR RELOCATOR KIT

- Relocates radiator to top mount position.
- Prevents cooling performance loss in muddy conditions.
- Uses existing radiator.
- Includes support, hardware and hoses.
- Engineered for easy cooling system bleeding and maintenance.
- Radiator not included.

G2, G2L

715001930

\$499.99



BELIEVE IT: YOUR RENEGADE IS A FEW MODS AWAY FROM BEING A TRUE MUD-READY BEAST

- RENEGADE SNORKEL KIT
- RENEGADE RADIATOR RELOCATOR KIT
- MUD STRAP

OUTLANDER SNORKEL KIT

- Comprehensive kit.
- Extended air intakes and CVT exhaust.
- CVT outlet integrates into pod cover.
- Must be installed on a vehicle without XT Handlebar Protector Kit.
- Ideal for muddy conditions.
- For 6x6, appropriate gauge support is required for best fit and finish.
- Not compatible with windshields.

G2 2015 & up, G2L (except X mr)

715005999

\$494.99

G2 (2012-2014 only)

715001730

\$474.99

G2L (X mr models only)

G2L (X mr models only)

- Raised horn only.

• Provides higher intake.

• For best fit and finish, appropriate gauge support is required.

715002518

\$119.99



EXPERT CHOICE

Factory-design fit-and-finish for outstanding deep mud and water fording performance.

NEW SELF-CLEARING FOOTWELLS

- Made from aluminum.
- Replace original footwells.
- Feature large evacuation ports to avoid mud and snow accumulation in footwells.
- Aggressive design for improved traction.
- Not compatible with Body Side Protectors.
- Sold in pairs.

G2 2015 & up, G2L

715004759

\$314.99

EXPERT CHOICE

Aids in rider traction and clears heavy mud and snow debris with ease.

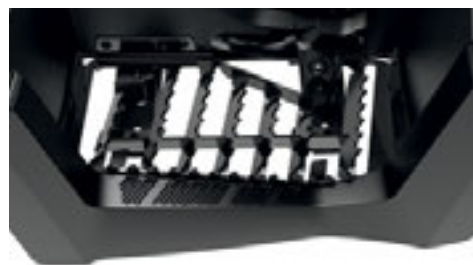

X MR TRACTION PLATES

- Provide extra foot grip for driver when riding in extreme mud conditions.
- Help driver maintain ideal riding position to maximize vehicle traction.
- Made of aluminum.
- Not meant for a passenger.

G2, G2L (MAX models only)

715001752

\$129.99



FOOTPEG KIT

- Provides maximum integrated grip and more stability during vigorous riding.
- Kick-up end generates added grip during hard cornering.
- Made of aluminum.
- Sold in pairs.

G2, G2L

715001131

\$56.99



RENEGADE

RENEGADE SNORKEL KIT

- Comprehensive kit.
- Extended air intakes and CVT exhaust.
- CVT outlet integrates into pod cover.
- Ideal for muddy conditions.

G2S

715006000

\$624.99



ADAPTER KIT

(Not illustrated)

- Necessary to install the G2S Snorkel Kit (715001928) on 2012 to 2014 models.

G2S (for 2012-2014 models only)

715003122

\$55.99

RENEGADE RADIATOR RELOCATOR KIT

- Relocates radiator to top mount position.
- Prevents cooling performance loss in muddy conditions.
- Uses existing radiator.
- Includes support, hardware and hoses.
- Engineered for easy cooling system bleeding and maintenance.
- Radiator not included.
- Renegade Extreme Front Bumper (715002469) required for installation (except X mr).

G2S

715001929

\$494.99



OUTLANDER | RENEGADE

MUD STRAP

- Convenient sturdy grab-handle.
- Lets drivers redistribute their weight for improved traction in demanding conditions.
- Not compatible with XT Handlebar Protector Kit (703100352).

G2, G2L, G2S

715003053

\$46.99



RADIATOR PROTECTOR

- Metal shield that mounts over radiator face, providing protection from stones and branches.

G2, G2S (except G2S with 500 engine)

715001744

\$78.99

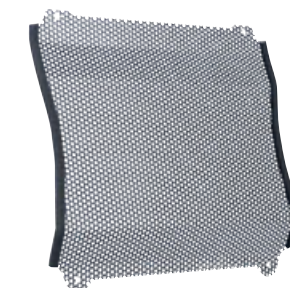



**YOSHIMURA
GIVES YOU THE
EDGE WITH MORE
PERFORMANCE
& LESS WEIGHT**

YOSHIMURA SLIP-ON EXHAUST

- Made from 304-grade stainless steel.
- Better sounding, better looking and lighter than stock muffler.
- USDF/USDA approved spark arrester.
- NON EPA compliant (for racing application only).
- Not EC compliant.
- Fuel injection system tuning not required.
- Not compatible with CARB, NRMM & T Category models 2018 and up.

OUTLANDER

G2 2018 & prior (except 6x6 models)
715001738
\$514.99

G2 2019 & up (except 6x6 models)
715005480
\$539.99



RENEGADE

G2S 2018 & prior (except 570 engine and X mr models)
715001739
\$659.99

G2S 2019 & up (except 570 engine and X mr models)
715005481
\$669.99



**EXPERT
CHOICE**

Sound, engineering, and style: This exclusive slip-on Yoshimura exhaust roars like no other.

OUTLANDER | RENEGADE



FOX SHOCKS

- Engineered for the more aggressive riders.
- Offer increased bump absorption and better roll control.
- Offer a slightly firmer ride than standard kits but remain very versatile for all-around use.
- Kit includes 4 shocks and springs.
- Rebuildable.
- Threaded preload adjusters.

G2 2012-2018 (except X mr, XT-P, Limited & 6x6 models), G2 X mr 650 (2012-2018), G2S (Base model with 500 & 570 only), G2L & G2L MAX

715001471
\$1,314.99
G2, G2S 2019
715005469
\$1,559.99



FOX PERFORMANCE SHOCKS 1.5 PODIUM X RC2 HPG

- High-performance front and rear shocks.
- Allow handling to readily adapt to terrain and riding style.
- Easy-adjust dual-speed compression, rebound and preload settings.
- Standard on G2S X xc.

G2 2012-2018 (except X mr, Limited & 6x6), G2 X mr 650 & G2S (Base model & X mr 570 only)

715003201
\$2,419.99
G2 2019
715005470
\$2,379.99



FRONT SHOCK COVERS

- Feature ventilation holes.
- Offer added protection in rough terrain and weather conditions.
- Sold in pairs.

G2, G2L, G2S
715500301
\$46.99

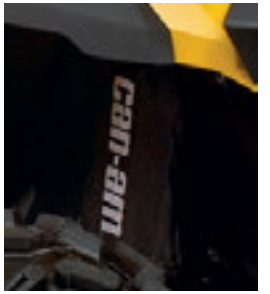

HEAVY-DUTY SPRINGS

- Heavy-duty springs provide enhanced stiffness.
- Perfect for snow clearing and hauling heavy loads.
- Improves handling and helps prevent accidental overturns.
- Sold in pairs.
- Standard on Outlander Pro and Mossy Oak models.

Front
G2 2012-2018 (Base model, DPS, XT, X mr with 650 engine only & Limited), G2S (Base model with 500 & 570 engines only)

715003199
\$129.99

Rear
G2 2012-2018 (Base model, DPS, XT & X mr with 650 engine only), G2S (Base model with 500 & 570 engines only)

715003200
\$129.99

Front & Rear
G2 2019 (Base, DPS & XT models)

715005159 **New**
\$369.99

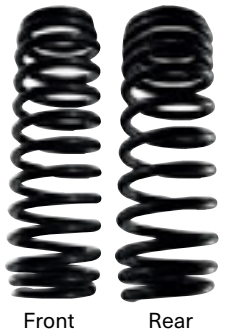

Front Rear

FOAM AIR FILTER BY TWINAIR[†]

- Maximizes performance by increasing air flow throughout RPM range.
- Maintenance-friendly, i.e. just wash, re-oil and re-use after riding in severely dusty/muddy environments.

G2, G2S, G2L
715001333
\$91.99



EMERGENCY KIT

- Complete emergency kit provides all essential equipment and supplies to get out of most unfavorable situations powersport enthusiasts can find themselves in.
- Includes: Jumper Cables, Air Compressor, Tire Repair Kit, Ratchet Tie-Down, Duct Tape, Tow Strap 3,300 lb (1,500 kg), Zip-Ties, Cloth Rags.

715004359
\$174.99



OUTLANDER | RENEGADE

TRAILERING COVERS

- Heavy-duty canvas made of UV-resistant solution-dyed polyester.
- Protect windshield and colored panels from abrasion.
- All high-abrasion areas are reinforced with a double canvas layer.
- Opening for fuel cap access.
- Weather-resistant trairling cover protects your vehicle during transportation.
- Quick and easy installation.
- Designed to perfectly fit your vehicle with or without Can-Am accessories.

G2 (except MAX models)	G2 (MAX models only)	G2L (except MAX models)	G2L (MAX models only)	G2S (except X mr models)
715001737	715001736	715002026	715002025	715000683
\$239.99	\$274.99	\$239.99	\$244.99	\$204.99

STORAGE COVERS

- Weather-resistant storage covers.
- For vehicle storage only.
- UV-resistant solution-dyed polyester construction.
- Quick and easy installation.
- Designed to perfectly fit your vehicle with or without Can-Am accessories.

G2, G2L, G2 Xmr (except 1000), G2L Xmr, G2S, G2S Xmr	G2, G2L (MAX models only)	G2, G2L (except MAX models)	G2 MAX, G2Xmr 1000, G2L MAX
715001720	715001668	715001597 • Mossy Oak Break-Up Country Camo	715001735 • Mossy Oak Break-Up Country Camo
\$204.99	\$209.99	\$274.99	\$289.99



BOLT-ON[®] RETRACTABLE RATCHETING TIE-DOWNS

- Perfect for transporting your powersport vehicle or securing loads.
- Mounts easily: Bolts on any flat surface (e.g. truck bed or frame).
- 1" x 6' (2.5 cm x 1.8 m) tie-down strap with heavy-duty stitching that delivers a 500 lb (226 kg) working load strength and 1,500 lb (680 kg) break strength.
- Convenient retractable push button automatically slackens, spools and stores away strap, while the ratchet mechanism tightens the strap snugly to secure your vehicle or load into place.
- Rubber ratcheting handle provides firm grip, and the hook is vinyl coated to protect whatever surface it hooks into.
- Sold in pairs.

295100737
\$39.99



RATCHET TIE-DOWNS

- 400 lb (181 kg) safe working load.
- 1" x 10' (2.5 cm x 3 m) strap with Can-Am, Sea-Doo, and Ski-Doo logos.
- Deluxe ratchet with rubber handle.
- Coated S hooks.
- Pack of 2.

860200447 • Black/Grey
\$22.99



FLAG

- Make sure everyone knows what you're riding.
- Perfect for the dunes and new riders.
- 8-foot (2.4 m) length.
- Includes flag mount (715000127).

715000277 • Yellow
\$32.99

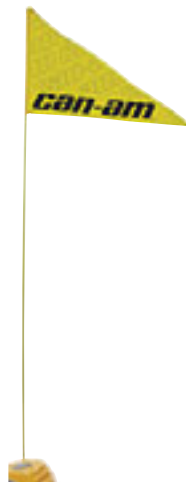

FLAG MOUNT

715000127
\$25.99

LOCKABLE GAS TANK CAP

- Protects your fuel.
- Meets EPA requirements.

G2, G2L, G2S
860200387
\$49.99



LICENSE PLATE BRACKET

- Provides specific area to install license plate.
- Mounts to rear of vehicle.

G2L
715002498
\$28.99

G2S
715001401
\$29.99



DECAL

- 6" x 12 3/4" (15 cm x 32 cm).

704901483
\$19.49



STORAGE COVER

- (Not illustrated)
- For storage use only.
- Heavy-duty elastic cord around bottom for secure fit.
- 100-denier polyester construction.
- Fits with or without windshield and mirrors.

G2 (6x6 models only)
715002492
\$334.99

APACHE
TRACK SYSTEMS

Each track has a specific purpose and is designed without compromise for work and play. Whether it's for deep snow riding, trail riding or for heavy loads, Apache tracks are akin to floating across the terrain.



WINTER TRACKS



YEAR ROUND TRACKS



APACHE BACKCOUNTRY

Finally explore winter with no traction limitations and no compromise, thanks to the unmatched performance of Apache Backcountry track kits. Engineered to thrive in the deepest snow—for work or play. Don't let winter stand in the way.

P.50

APACHE 360, 360 LT

These track kits improve your vehicle's ground clearance and increase its contact patch with the terrain. Adapt your track setup to the conditions you'll be riding in and the purpose of your ride, with the Apache 360 and 360 LT systems: as our all-season, all-terrain masterpieces.

P.51-52

WINTER TRACKS

GET THE MOST OUT OF YOUR CAN-AM ATV THIS WINTER FOR ALL YOUR ENDEAVORS.

Explore without compromise. Ride on untouched trails, traveling deep into winter's embrace and you'll know: The same technology behind our world-renowned snowmobiles is at your command. With a larger contact patch, and more aggressive track design, travel beyond what you thought possible with the best snow performance.

COVERED BY A 1-YEAR WARRANTY



OUTLANDER | RENEGADE

APACHE BACKCOUNTRY

EFFICIENT FRAME AND RAIL DESIGN ENSURES WEIGHT IS EVENLY DISTRIBUTED ON SNOW



LARGEST CONTACT PATCH ANYWHERE: 23% MORE THAN THE APACHE 360 LT

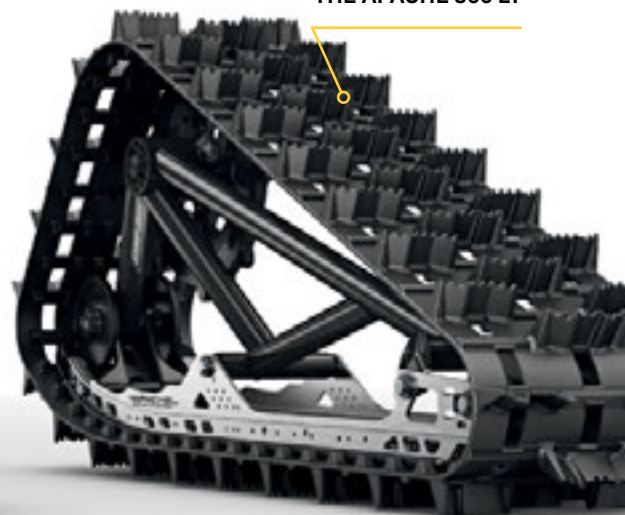

EASY-TO-OPERATE SNOWMOBILE-TYPE SLIDING TENSIONER

APACHE BACKCOUNTRY TRACK SYSTEM

- Designed to deliver the best flotation level and deep-snow performance on the market.
- Contact patch is 23% bigger than the Apache 360 LT.
- Impressive added ground clearance of 7" (18 cm), keeps the vehicle out of deep snow.
- Aggressive track design with 2" (5 cm) lug height for maximum traction on snow.
- Apache Backcountry Mounting Kit and engine and CVT air intake pre-filters are required.
- For winter use only.

G2 (except 6x6 models), G2S, G2L

715003042

\$5,499.99

IDLER WHEEL KIT

- Reduces drag and rolling resistance.
- Includes 2 wheels, brackets and hardware.
- Add up to 2 kits per rear track.
- Can extend slider life in hardened snow conditions.

Apache Backcountry Track System (rear tracks only)

860201230 • 141 mm

\$77.99

SLIDERS WITH VESPEL[†] INSERTS

- Use DuPont Vespel inserts for less friction.
- Longer life.
- Can be cut to desired length.
- 8 needed per vehicle.
- Sold individually.

Apache Backcountry Track System

503194815

\$109.99



RAIL ICE SCRATCHERS

- Provide additional lubrication in hard and icy conditions.
- Rail mounted, small, light.
- Design expands on coil concept to allow reversing without damage.
- Easily stored when not in use.

Apache Backcountry Track System

860201728

\$109.99



YEAR ROUND TRACKS

WORK & PLAY YEAR ROUND THROUGH MUD, SNOW, & ALL TYPES OF TERRAIN.

Rise above terrain, weather, and whole seasons with the Apache 360, 360 LT and 360 LT 6x6 track kits — the upgrade that takes the Can-Am experience to another level. Designed for superior traction and carrying heavier loads in soft terrain, they can be used with your ATV year round for exploring and completing tough tasks.

COVERED BY A 2-YEAR WARRANTY



OUTLANDER | RENEGADE

APACHE 360 & 360 LT

ADDED GROUND CLEARANCE OF 4.5" (11.4 CM)

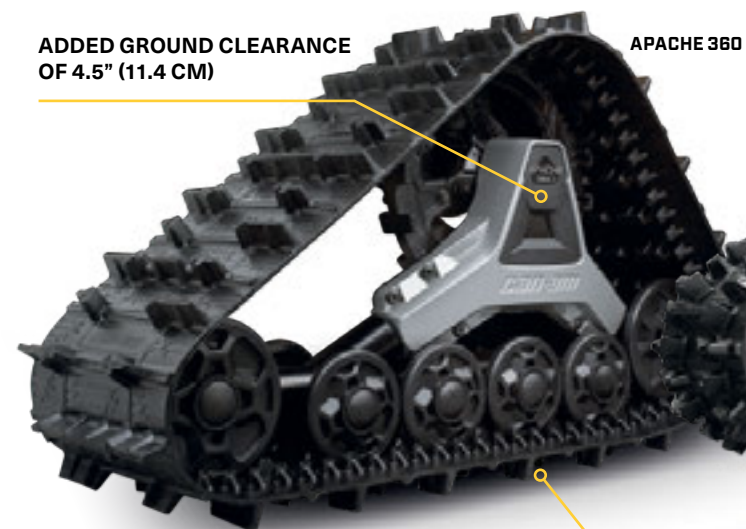

APACHE 360

APACHE 360 LT

TOTAL GROUND SURFACE AREA: 2,079.7 IN² (13,417 CM²)

UNIQUE ADJUSTABLE CONTACT PATCH SYSTEM TO TACKLE THE TOUGHEST YEAR-ROUND CONDITIONS

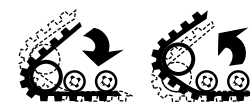

APACHE 360 TRACK SYSTEM

- Multifunctional tracks perfect for any Can-Am ATV.
- Average ground clearance of 16" (41 cm).
- 1" (2.5 cm) lugs in the front and 1.25" (3.2 cm) in the back.
- Apache 360 & 360 LT Mounting Kit and engine and CVT air intake pre-filters are required.

G2 (except 6x6 models), G2L, G2S

715005240

\$3,864.99

APACHE 360 LT TRACK SYSTEM

- Multifunctional tracks designed to support heavy loads and to fit on most Can-Am off-road vehicles.
- Front wheel height adjustment provides enhanced attack angle and better performance over rough terrain when raised or increased contact patch for improved flotation when lowered.
- Average ground clearance increase of 4.5" (11.4 cm).
- 1" (2.5 cm) lugs in the front and 1.25" (3.2 cm) in the back.

G2, G2S, G2L

715005103

\$4,999.99

RUBBER OVER MOLDED HEAVY-DUTY DOUBLE BEARING WHEELS AND OFFSET WHEEL SPACING REDUCE FRICTION AND VIBRATION WHILE ENSURING RELIABILITY

GROUND SURFACE AREA IS 7 TO 9% LARGER THAN THE APACHE 360's

- Apache 360 LT Mounting Kit, Track DPS Module and Engine & CVT Pre-Filter Kit are required.
- Reliable heavy-duty build.
- EC compliant.
- Contact patch is 7 to 9% bigger than the Apache 360's.
- Apache 360 & 360 LT Mounting Kit, Track DPS Module and engine and CVT air intake pre-filters are required.



OUTLANDER 6X6

APACHE 360 LT 6X6

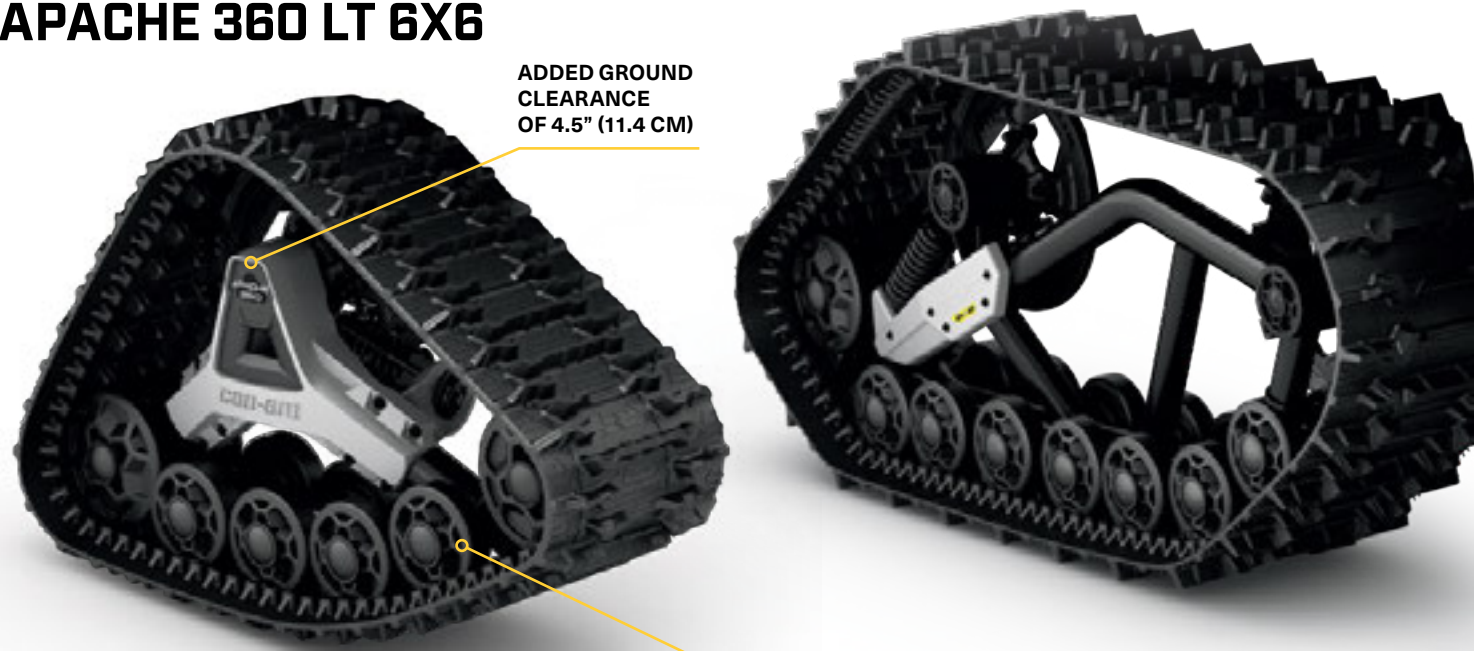

ADDED GROUND CLEARANCE OF 4.5" (11.4 CM)

UNIQUE ADJUSTABLE CONTACT PATCH SYSTEM TO TACKLE THE TOUGHEST YEAR-ROUND CONDITIONS



RUBBER OVER MOLDED HEAVY-DUTY DOUBLE BEARING WHEELS AND OFFSET WHEEL SPACING REDUCE FRICTION AND VIBRATION WHILE ENSURING RELIABILITY

APACHE 360 LT (6X6) TRACK SYSTEM

- Multifunctional tracks designed to support heavy loads and to fit on most Can-Am off-road vehicles.
- Front wheel height adjustment provides enhanced attack angle and better performance over rough terrain when raised or increased contact patch for improved flotation when lowered.
- Average ground clearance increase of 4.5" (11.4 cm).
- 1" (2.5 cm) lugs in the front and 1.25" (3.2 cm) in the back.
- Apache 360 LT Mounting Kit, Track DPS Module and Engine & CVT Pre-Filter Kit are required.
- Reliable heavy-duty build.
- EC compliant.
- Exclusively for the Outlander 6x6.
- Recommended for use on snow only.

G2, G2L (6x6 only)
715005104
\$6,864.99

ATV TRACK SYSTEM FITTING GUIDE

Track Kit	Vehicle	Mounting Kit	DPS Module	Pre-Filter
APACHE BACKCOUNTRY 715003042	G2, G2S 2018 & prior & G2L	715004830	715005243	Air Intake Pre-Filter 715004729 + CVT Air Intake Pre-Filter 715003483 <i>Standard on G2 models and G2L PRO model</i>
	G2, G2S 2019 & up	715004796	Models with Intelligent Throttle Control (ITC™): 715004707 Everything else: 715005243	
APACHE 360 715005240	G2, G2S 2018 & prior & G2L	715004829	715005243	
	G2, G2S 2019 & up	715004795	Models with Intelligent Throttle Control (ITC™): 715004707 Everything else: 715005243	
APACHE 360 LT 715005103	G2, G2S 2018 & prior & G2L	715004829 + 715003063 (adaptor)	715005243	
		G2, G2S 2019 & up		
APACHE 360 LT 6X6 715005104	G2 2018 & prior, G2L (6x6 models)	715004991	Models with Intelligent Throttle Control (ITC™): 715004707 Everything else: 715005243	
	G2 6x6 models 2019 & up	715005105		

APACHE BACKCOUNTRY MOUNTING KIT

(Not illustrated)
• Required for installation of the Apache Backcountry Track System.
• DPS module and pre-filter are required and sold separately.
G2 2018 & prior, G2S 2018 & prior, G2L 715004830
\$609.99

G2 2019, G2S 2019 715004796
\$609.99

TRACK DPS MODULE

(Not illustrated)
• An innovative DPS module that ensures speedometer accuracy and optimized steering assist, which make for perfect track control and riding ease.
• Required to install the Apache Track Systems.

Models without Intelligent Throttle Control (ITC™)
715005243
\$159.99

Models with Intelligent Throttle Control (ITC)
715004707
\$159.99

APACHE 360 & 360 LT MOUNTING KIT

(Not illustrated)
• Required to install Apache 360 & 360 LT Track Systems.
• Requires Apache 360 LT ATV Adapter (715003063) for installation of the Apache 360 LT Track System.
• DPS module and pre-filter not included.
G2 2018 & prior (except 6x6 models), G2S 2018 & prior, G2L 715004829
\$274.99

G2 2018 & prior, G2L (6x6 models) 715004991
G2 6x6 models 2019 & up 715005105
\$214.99

APACHE 360 LT ADAPTOR

(Not illustrated)
• Required to install an Apache 360 LT Track System.
• Apache 360 and 360 LT Mounting Kit also required.
G2 (except 6x6 models), G2S, G2L 715003063
\$179.99

ENGINE AIR INTAKE PRE-FILTER

• Adds extra protection to your engine in harsh riding conditions.
• Filter blocks particles larger than 0.005" (0.13 mm).
• Necessary to maintain vehicle warranty when tracks are installed.
G2, G2L, G2S 715004729
\$38.99



CVT AIR INTAKE PRE-FILTER

• Adds extra protection to your engine in harsh riding conditions.
• Filter blocks particles larger than 0.007" (0.19 mm).
• Easy, tool-less installation.
• Necessary to maintain vehicle warranty when tracks are installed.
• Required to install the Apache and Backcountry Track Systems.
• Standard on Outlander 650, 850, 1000, 1000R engines and G2L PRO.
715003483
\$46.99



NEW SELF-CLEARING FOOTWELLS

- Made from aluminum.
- Replace original footwells.
- Feature large evacuation ports to avoid mud and snow accumulation in footwells.
- Aggressive design for improved traction.
- Not compatible with Body Side Protectors.
- Sold in pairs.

G2 2015 & up, G2L
715004759
\$314.99



Aids in rider traction and clears heavy mud and snow debris with ease.

PROMOUNT — PLOWS



FIT & COMPATIBILITY



QUALITY & RELIABILITY



STYLE & VISION

The new ProMount lineup was created for both professional operators and enthusiasts looking to take their tool kit to the next level. Designed to work as efficiently as possible, Can-Am reimaged the plow from mount to blade.

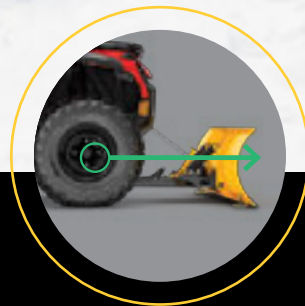

Underbelly mounting plate provides the optimal angle of attack for best push strength.



The forward mounted push frame provides industry leading lift height.



Low profile mounting plate has little impact on ground clearance and can be left installed year round.

MOST EFFICIENT MOUNTING SYSTEM

CONNECTS WITH A CLICK

Attachable in **FOUR EASY STEPS**, the Can-Am ProMount plow system is the fastest, easiest way to start plowing and get the job done—minimal effort for maximum result.



1 Drive straight toward the plow.



2 Attach the winch cable to the plow using a guiding hook/roller.



3 Lift the plow until it clips onto the mounting plate.



4 Remove the winch cable from the guide. You're ready to plow.

OUTLANDER | RENEGADE

CAN-AM PROMOUNT STEEL PLOWS

Consult your dealer for the best plow width. Made from 12-gauge steel and designed for efficient plowing, the ProMount steel blades are offered in multiple sizes to fit jobs large or small.

CAN-AM PROMOUNT STEEL PLOW KITS

These kits include:

- Can-Am ProMount Steel Blade
- Push Frame with Quick-Attach System
- Mounting Plate

54" [137 CM] BLADE

G2, G2L, G2S

- 715005200 • Black
 - 715005428 • Yellow
- \$839.97**

60" [152 CM] BLADE

G2, G2L, G2S

- 715005201 • Black
 - 715005434 • Yellow
- \$864.97**

66" [168 CM] BLADE

G2, G2L, G2S

- 715005427 • Black
 - 715005435 • Yellow
- \$929.97**

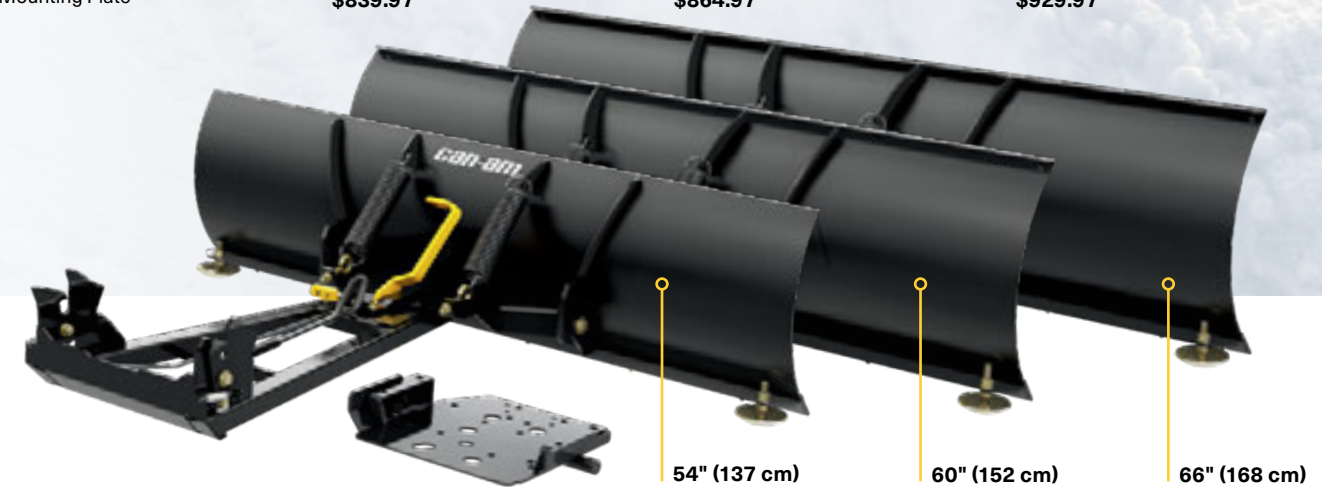

CAN-AM PROMOUNT STEEL BLADES

- Blades available individually to create your own kit.
- Compatible with Can-Am ProMount Blade accessories to further enhance plow versatility (some plow accessories are not compatible with 54" [137 cm] plows).

54" [137 CM] BLADE

- Not compatible with ProMount Drift Cutters, Blade Extensions and Edge Markers.
 - Clears 50" (127 cm) when plow is fully angled.
 - Blade height of 14.75" (37 cm).
- Fits ProMount Push Frame**
- 715004472 • Black
 - 715005316 • Yellow
- \$309.99**

60" [152 CM] BLADE

- Clears 54" (137 cm) when plow is fully angled.
 - Blade height of 17" (43 cm).
- Fits ProMount Push Frame**
- 715004202 • Black
 - 715005317 • Yellow
- \$334.99**

66" [168 CM] BLADE

- Clears 60" (152 cm) when plow is fully angled.
 - Blade height of 17" (43 cm).
- Fits ProMount Push Frame**
- 715006337 • Black
 - 715006338 • Yellow
- \$399.99**

New 72" [183 CM] BLADE

- Clears 66" (168 cm) when plow is fully angled.
 - Blade height of 17" (43 cm).
- Fits ProMount Push Frame**
- 715004474 • Black
 - 715006021 • Yellow
- \$479.99**



by choosing any plow type/length that you'd like for your push frame. **ProMount Push Frames are compatible with all the blades.**

OUTLANDER | RENEGADE

CAN-AM PROMOUNT FLEX2 PLOWS

HMWPE (High Molecular Weight Polyethylene) technology gives Flex2 greater reliability, resistance to impact, and immunity to rust or deformation. Tough on jobs but flexible in the face of obstacles, the Flex2 blade simplifies work.

CAN-AM PROMOUNT FLEX2 PLOW KIT

- This kit includes:**
- Can-Am ProMount Flex2 Blade
 - Push Frame with Quick-Attach System
 - Mounting Plate

60" (152 CM) BLADE
G2, G2L, G2S
 ■ 715005202 • Black
\$989.97



60" (152 cm)

CAN-AM PROMOUNT FLEX2 BLADES

- Blades available individually to create your own kit.
- Compatible with Can-Am ProMount Blade accessories to further enhance plow versatility.

60" (152 CM) BLADE
 • Clears 54" (137 cm) when plow is fully angled.
Fits ProMount Push Frame
 ■ 715004203 • Black
\$459.99

New 72" (183 CM) BLADE
 • Clears 66" (168 cm) when plow is fully angled.
Fits ProMount Push Frame
 ■ 715004485 • Black
\$609.99



60" (152 cm)

72" (183 cm)



by choosing any plow type/length that you'd like for your push frame. **ProMount Push Frames are compatible with all the blades.**



YOUR JOB, YOUR CHOICE

Get a custom solution that truly fits the task at hand—with quality components and no cut corners. The ProMount push frame, mounting plate and blades are a universal system that can be adapted to your specific Can-Am and jobsite.

OUTLANDER | RENEGADE

CAN-AM PROMOUNT PUSH FRAME WITH QUICK-ATTACH SYSTEM

- Heavy-duty steel tubes designed to withstand the roughest use.
- Mid-mount carriage provides ultimate push strength and traction.
- Designed for maximum plow lift height.
- Features a self-aligning quick-attach system, an easy foot release pedal and an ergonomic handle for plow angle adjustment.
- Plow Roller Fairlead and Plow Limit Switch recommended to extend winch cable lifespan.
- Can-Am ProMount Mounting Plate required for installation.
- Blade swivels left or right, 5 positions.
- Large pin designed for easy blade rotation to eliminate dirt and snow buildup at pivot point.

G2, G2L, G2S
 715004339
\$409.99



Compatible with all ProMount plows

CAN-AM PROMOUNT PUSH FRAME EXTENSION

- 12" (30 cm) push frame extension.
- G2, G2L, G2S**
 715004204
\$179.99

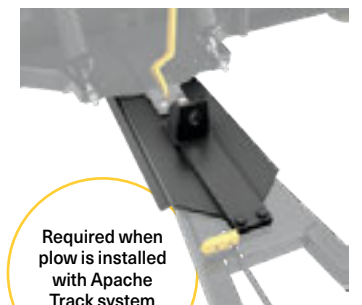

Required when plow is installed with Apache Track system

CAN-AM PROMOUNT MOUNTING PLATE

- Required to install the Can-Am ProMount Push Frame with Quick-Attach System.
- Mounting plate precision-designed to stay on year round without compromising ground clearance.
- Fits on ATVs, Maverick Trail or Maverick Sport with or without Can-Am Skid Plates.

G2, G2L, G2S
 715004338
\$119.99



OUTLANDER | RENEGADE

CAN-AM PROMOUNT PLOW ACCESSORIES

CAN-AM PROMOUNT EDGE MARKERS

- Help locate the edges of your plow.
- Height: 24" (60 cm).
- Sold in pairs.
- Compatible with Can-Am ProMount Steel and Flex2 Blades with or without Blade Extensions (except for the Can-Am ProMount Steel 54" (137 cm) Blades).

G2, G2L, G2S

715004206

\$49.99

CAN-AM PROMOUNT DRIFT CUTTERS

- Help keep snow in the plow.
- Dimensions: 17" x 13" (43.2 cm x 33 cm).
- Sold in pairs.
- Compatible with Can-Am ProMount Steel and Flex2 Blades with or without Blade Extensions (except for the Can-Am ProMount Steel 54" (137 cm) Blades).

G2, G2L, G2S

715004207

\$149.99

CAN-AM PROMOUNT PLASTIC WEAR BLADE

- To help prevent scratches on smooth driveways and markable surfaces.

G2, G2L, G2S

54" (137 cm)	60" (152 cm)	66" (168 cm)	72" (183 cm)
715004480	715004481	715004482	715004483
\$99.99	\$99.99	\$99.99	New \$159.99

CAN-AM PROMOUNT BLADE EXTENSIONS

- Add 3" (8 cm) each side.
- Compatible with Can-Am ProMount Blades (except for Can-Am ProMount Steel 54" (137 cm) Blade).
- Longer Wear Blade can be installed to further extend the extra length already provided by the extensions.
- Compatible with Can-Am ProMount Steel and Flex2 Blades (except for the Can-Am ProMount Steel 54" (137 cm) Blades).

G2, G2L, G2S

- 715004205 • Black
- 715005319 • Yellow

\$124.99

PLOW ROLLER FAIRLEAD

- Larger diameter lower roller reduces wear on wire rope for plow application.
- Can be used with all ProMount plows.

G2, G2L, G2S

705009222

\$77.99



PULLEY KIT

- Pulley kit to be used in conjunction with the winch when using a snow plow.
- Recommended to increase winch efficiency.
- To be used with the XT Front Bumper.

715000279

\$64.99



SYNTHETIC WINCH CABLE FOR PLOWING

- Specially designed for plowing applications.
- 8' (2.4 m) section of durable, extra-strong synthetic rope.
- Stands up to repeated, sharp angle pulls used to lift heavy plow blades.
- Temporarily replace your winch rope for plow season to save wear and tear on wire rope.

715000540

\$50.99

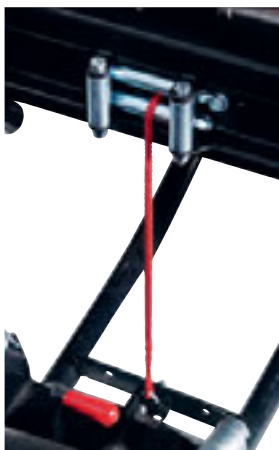

PLOW LIMIT SWITCH

- (Not illustrated)
- For controlling the cable tension when over raising your plow system.
- Prevents winch, plow push frame and vehicle damage.

G2, G2L, G2S

715004775

\$139.99

REAR TIRE CHAINS

- Improve your traction in mud and snow.
- Sold in pairs.

26" x 10" x 12"

715500218

\$104.99

25" x 10" x 12"

715000225

\$91.99



ITP TERRACROSS TIRE

- This smooth-riding tire will command every bit of traction from the ground while still managing to float across loose snow, sand and mud.
- Features extreme-duty construction for improved puncture protection, extra-tough rubber compound for increased tread life, and the interlocking tread pattern and wide footprint make it one of the toughest and grippiest radials around.
- Not EC compliant.

G2 XTP, G2 Limited

Front • 26" x 8" x 14"

705401906

\$230.99

Rear • 26" x 10" x 14"

705502421

\$251.99



GROUND-GRIPPING TRACTION MEETS LOOSE MUD MANEUVERABILITY. THE TOUGH TIRE WITH THE SMOOTH RIDE.

ITP CRYPTID TIRE

- Graduated lug height and paddle-like shoulder configuration provide maximum side bite for climbing in and out of the mud without compromising ride comfort on trails and hard pack.
- 6-ply rated.
- 30" x 9" x 14".

G2 X mr 850 & 1000R 2018 & up,

G2S X mr 1000R 2018 & up

705402178

\$245.99



ZILLA TIRE BY MAXXIS*

- Sold individually.

Front

27" x 10" x 14"

705401302

\$204.99

Rear

27" x 12" x 14"

705501703

\$224.99



ITP MEGA MAYHEM

- 1.5" tread depth mud thrower tires.
- Surprisingly smooth ride on hard pack surfaces.
- 6-ply rated.

G2 X mr 570 & 650 2018 & up,

G2S X mr 570 2018 & up

Front

28" x 9" x 12"

705402131

\$266.99

Rear

28" x 11" x 12"

705502645

\$271.99



CARLISLE ACT TIRE

G2 (500-1000 XT models only)

Front

26" x 8" x 12"

705401333

\$168.99

705401334 • C€

Rear

26" x 10" x 12"

705501769

\$209.99

705501770 • C€

G2 (400 XT models only)

Front

25" x 8" x 12"

705400606

\$147.99

705400326 • C€

Rear

25" x 11" x 12"

705500933

\$189.99

705500598 • C€

GORILLA SILVERBACK TIRE

- AT30X9-14 Gorilla Silverback mud tire.
- Sold individually.
- Not EC compliant.

G2 (850 & 1000 models only)

30" x 9" x 14"

705400962

\$276.99



CARLISLE ACT HD TIRE

Front

26" x 8" x 12"

705401736

\$178.99

Rear

26" x 10" x 12"

705502297

\$220.99



MAXXIS MUDZILLA TIRE

- Not EC compliant.

G2 (X mr 570 & 650 models only)

Front

28" x 8" x 12"

705401391

\$266.99

Rear

28" x 10" x 12"

705501836

\$215.99



CARLISLE BADLANDS A/R TIRE

G2 (500-1000 Base models only)

Front

26" x 8" x 12"

705401331

\$158.99

705401332 • C€

Rear

26" x 10" x 12"

705501767

\$158.99

705501768 • C€





CARLISLE TRAIL WOLF TIRE

G2 (400 Base models only)
Front 25" x 8" x 12" 705401625 \$178.99 705400607 • CE
Rear 25" x 11" x 12" 705502164 \$178.99 705502165 • CE



KENDA KLAW MXR TIRE

DS 90 X
Front - 20" x 6" x 10" V42711DGF01HLL \$111.99
Rear - 18" x 10.5" x 8" V42712DGF01HLL \$114.99



ITP HOLESHOT ATR TIRE

G2S
Front 205/80R12 25" x 8" x 12" 705400600 \$199.99 705400475 • CE
Rear 270/60R12 25" x 10" x 12" 705500926 \$220.99 705500820 • CE



REAR TIRE CHAINS

• Improve your traction in mud and snow.
 • Sold in pairs.
26" x 10" x 12" 715500218 \$104.99
25" x 10" x 12" 715000225 \$91.99
26" x 9" x 12"
27" x 9" x 14"



DURO THRASHER TIRE

DS 90/70
Front - 19" x 7" x 8" V42711DGF000LL \$87.99
Rear - 18" x 9.5" x 8" V42712DGF010LL \$97.99



KENDA KNARLY TIRE

DS 250
Front - 22" x 7" x 10" S44710RCA000 \$122.99
Rear - 20" x 11" x 9" S42710RCA000 \$132.99



RIMS

14" RIM

• Premium cast aluminum black painted with machining and clear coat rim.
 • Center hole: 72 mm.
 • Bolt circle pattern: 4/136 mm.

G2 DPS, G2 XT, G2 MAX 650, G2 MAX XT, G2 MAX Limited

Front - 14" x 6.5" offset = 40 mm 705401853 • Black and machined \$153.99 705401852 • Black with clear coat 705401851 • Silver with clear coat \$143.99
Rear - 14" x 8.5" offset = 50 mm 705502402 • Black and machined \$169.99 705502401 • Black with clear coat 705502400 • Silver with clear coat \$158.99



NOTE: Matching Nuts - 250100100 Black, 250100082 Chrome / Matching Cap - 705400928

14" RIM

G2 DPS, G2 XT, G2 MAX Limited, G2 North Edition, G2 MAX North Edition
Front - 14" x 6.5" offset = 40 mm 705402309 • Black and machined \$143.99 705402222 • Black with clear coat 705402307 • Silver with clear coat \$143.99
Rear - 14" x 8.5" offset = 50 mm 705502770 • Black and machined \$169.99 705502702 • Back with clear coat 705502768 • Silver with clear coat \$158.99



OUTLANDER X MR AND DEFENDER RIM

• Cast aluminum rim with trend setting explosive styling so you can ride - and look - like a trailblazer.

X mr models front and rear wheels

Front
 14" x 6.5" offset = 10 mm
 705401848 • Black and machined \$169.99
 705401849 • Black



NOTE: Matching Nuts - 250100100 Black, 250100082 Chrome / Matching Cap - 705401541

OUTLANDER X MR RIM - ITP-SS212*

• Black with machining and clear coat rim.
 • Sold individually.

G2 (X mr models only)

Front and Rear - 14" x 6"

705400877 • Black and machined \$163.99



NOTE: Matching Nuts - 250100100 / Matching Cap - 705400963

OUTLANDER RIM (CAMO MODEL)

• Black with clear coat aluminum rim.
G2, G2L, G2S
Front - 12" x 6" offset = 41 mm 705401127 • Black with clear coat \$184.99
Rear - 12" x 7.5" offset = 51 mm 705501493 • Black with clear coat \$194.99



LOCKOUT 393 14" RIM BY VISION*

• Sold individually.

Front - 14" x 7"

Bolt circle pattern: 4/136 mm

Wheel offset: 4 + 3

705401363 \$139.99

Rear - 14" x 8"

Bolt circle pattern: 4/136 mm

Wheel offset: 4 + 4

705501787 \$139.99



NOTE: Matching Nuts - 250100100 / Matching Cap - 705401362

12" BEADLOCK RIM

• Black with clear coat aluminum rim.
 • Needs 16 bolts (250000435) for installing the beadlock.
 • Choice of beadlock color (not included).

G2, G2L, G2S

Front - 12" x 6" offset = 41 mm

705401678 • Black \$245.99

Rear - 12" x 7.5" offset = 51 mm

705502244 • Black \$245.99



12" BEADLOCK

• Cast aluminum beadlock.
 • Must be installed on Front Rim (705401678) and Rear Rim (705502244).

G2, G2L, G2S

705401763 • Can-Am Red

705401156 • Yellow

705401533 • Orange Crush

705401812 • Manta Green

\$79.99

NOTE: Matching Nuts - 250100100 / Matching Cap 705400928

14" BEADLOCK RIM

• Black with clear coat aluminum rim.
 • Choice of beadlock color (not included).
 • Needs 16 bolts (250000435) for installing the beadlock.

G2

Front - 14" x 6.5" offset = 41 mm

705401594 \$276.99

Rear - 14" x 8" offset = 51 mm

705502146 \$276.99



14" BEADLOCK

• Cast aluminum beadlock.
 • Must be installed on Front Rim (705401594) and Rear Rim (705502146).

G2

705401586 • Manta Green

705401702 • Octane Blue

705401837 • Can-Am Red

705401840 • Black

\$87.99

NOTE: Matching Nuts - 250100100 / Matching Cap 705400928

*Consult your operator's guide/owner's manual for proper tire type and rim sizing. Improper tire type and rim selection may affect vehicle handling. Check with your local authorities for proper regulation.

APPAREL

Clothing, helmets, glasses and everything else you need to shift your Can-Am experience into high gear.

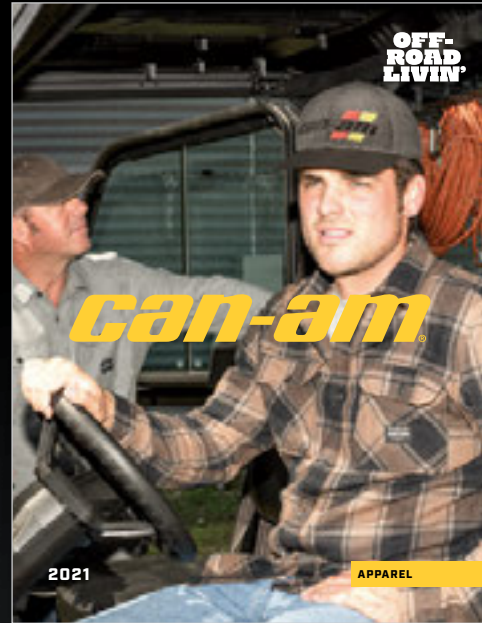

PARTS & MAINTENANCE

Essential items to keep your Can-Am tearing up the tarmac, including oils, filters maintenance products and cleaning products.



EXPLORE AN ENTIRE WORLD OF ADVENTURE WITH ALL OF OUR BRP PRODUCTS. BRP.COM



skt-doo *LYNX* *SEA-DOO* *can-am* *ROTAX* *ALUMACRAFT* *Manitou* *EVIRUDE*



WE'RE
BUILT
FOR
THIS

