

**OFF-  
ROAD  
LIVIN'**

***can-am***

**2021 ACCESSORIES**

**DEFENDER**

# YOUR JOB. OUR ACCESSORIES. LET'S GET IT DONE.



## FIT & COMPATIBILITY

FOR US, INNOVATION IS A NO BRAINER. ALL OUR ACCESSORIES WORK TOGETHER, RIGHT OUT OF THE BOX. SO TAKE YOUR PICK. THEN PICK SOME MORE.

## STYLE & VISION

WE'VE UPPED THE ANTE ON ACCESSORIES. NOT JUST DESIGNED TO LOOK GOOD, BUT PERFORM RIGHT FOR REAL RIDERS. ALL KILLER, NO FILLER.

## QUALITY & RELIABILITY

OUR CAN-AM ACCESSORIES ARE MADE RIGHT THE FIRST TIME. AND TO TOP IT OFF WE THREW IN A 1-YEAR WARRANTY. YOU'RE WELCOME. INSTALL THEM YOURSELF OR AT AN AUTHORIZED DEALER.

**can-am**

**BRP 1-YEAR  
LIMITED WARRANTY**

For new Can-Am accessories, genuine parts, and co-branded products sold through BRP. Includes items installed by you or an authorized BRP dealer.

# 2021

**can-am**  
**DEFENDER**

## ACCESSORIES

Built Inspirations	6
Roofs	12
Hard Cabs	15
Soft Cabs	16
Windshields & Mirrors	17
Doors	21
Rear Wind Protection	23
Skid Plates	25
Bumpers & Guards	26
LinQ: Easy On, Easy Off Cargo	33
Cargo & Storage	39
Racks & Holders	44
Lights	48
Audio & Communication Systems	52
Electrical & Electronic	54
Winches & Hitches	57
Seats	60
Performance	61
Track Systems	65
Promount Plows	69
Covers & Add-Ons	75
Tires & Rims	76

**CAN-AMOFFROAD.COM**

© 2020 Bombardier Recreational Products Inc. (BRP). All rights reserved. ®, TM and the BRP logo are trademarks of BRP or its affiliates. CARLISLE is a trademark of Carlisle Companies. CHAMUDE and HIPORA are registered trademarks of Kolon Industries, Inc. CLARINO is a trademark of Kuraray Co. Ltd. COOLMAX and THERMOLITE are registered trademarks of INVISTA for durable fabrics. DRIRELEASE is a registered trademark of Optimer Inc. FOX is a registered trademark of Fox Racing Canada. GARMIN and MONTANA are registered trademarks of Garmin Ltd. iPod is a registered trademark of Apple Inc. KOLPIN, GUN BOOT and IMPACT are registered trademarks of Kolpin Powersports Inc. KVB is a registered trademark of Kayaba. MicroSD is a registered trademark of SD Card Association. Mud Lite XTR and SS312 are trademarks of ITP Tires. NEXT G-1 VISTA is a trademark of Next Camo, LLC. NGK is a registered trademark of NGK Spark Plugs, Ltd. PRIMALOFT GOLD and PRIMALOFT BLACK are registered trademarks of Albany International Corp. TEFLON, TEFLON HT and KEVLAR are trademarks of E.I. DuPont de Nemours & Co. TWINAIR is a trademark of Twin Air USA. UNI is a trademark of UNIFILTER Inc. VELCRO is a registered trademark of Velcro Industries. WARN is a trademark of Warn Industries Inc. YUASA is a registered trademark of YUASA Batteries Inc. ZILLA and BIGHORN 2.0 are trademarks of Maxxis. SCOTT is a trademark of Scott Sports SA. The following trademarks are the property of their respective owners: BLUETOOTH, CREE, DURO, DWIT, HELLA, ITP, KENDA, MOSSY OAK, RAM, SUR LAST, VISION, XPS and YOSHIMURA. Baja Designs is a registered trademark of Baja Designs Inc. SS POWERSPORTS is a trademark of SS Power Sports LLC. Some models depicted herein may include optional equipment. Prices, if shown, are based on Manufacturer Suggested Retail Prices. Dealers may sell for a different price. For Canada and US, taxes are not included. Depending on location, products are distributed by BRP US Inc., Bombardier Recreational Products Inc., BRP European Distribution SA, BRP Finland Oy, BRP Australia Pty Ltd, or BRP Brasil Motorsports LTDA. BRP reserves the right, at any time, to discontinue or change specifications, prices, designs, features, equipment without incurring obligation.

**EXPERT  
CHOICE**

**LOOK FOR THIS LOGO THROUGHOUT THE CATALOGUE FOR EXPERT RECOMMENDATIONS ON INNOVATIVE, MUST-HAVE, ENTHUSIAST-READY PARTS AND ACCESSORIES THAT WILL HELP YOU CUSTOMIZE YOUR PERFECT OFF-ROAD MACHINE.**

# EXPERTLY-CHOSEN PACKAGES

ADD THE ACCESSORIES YOU WANT WITH 3 LEVELS OF UPGRADES: **STARTER**, **ADVANCED**, AND **PEAK**. OR MIX AND MATCH OPTIONS—IT'S YOUR RIDE.

## STARTER

Essential, recommended upgrades to immediately enhance any Can-Am vehicle.

## ADVANCED

The best all-round, do-anything upgrades that have proven popular with experienced riders and new owners alike. Transform your Can-Am for the years of riding ahead.

## PEAK

Limits are for other people: build your Can-Am Off-Road vehicle to overcome bigger obstacles & ride through larger adventures.



CAN-AM ACCESSORIES FOR GROWN-UP FUN.

DEFENDER PRO

# EXPLORE

## STARTER

715005276	ProVent Windshield	p. 20	\$944.99
715007081	Rear Polycarbonate Windshield	p. 23	\$454.99
715005754	Front Bumper	p. 27	\$339.99
715005777	Xtreme Front Bumper Plates	p. 27	\$299.99
715005774	Front Corner Protector	p. 27	\$219.99
715006012	Rear Bumper	p. 29	\$309.99
715002459	Side Mirror	p. 20	\$124.99
			<b>\$2,694.93</b>

## ADVANCED

715006325	Soft Doors	p. 22	\$1,219.99
715006001	Fender Flares	p. 30	\$329.99
715003873	Headache Rack	p. 40	\$289.99
715005415	Cargo Bed Protectors & Tie Rails	p. 29	\$339.99
715003870	Adventure Roof Rack	p. 44	\$634.99
715004778	LinQ 8 Gal Cooler Box	p. 36	\$459.99
			<b>\$5,969.87</b>

## PEAK

715006697	Skid Plate Kit	p. 25	\$2,234.95
715002019	Complete Overhead Audio System	p. 53	\$1089.99
715004007	39" (99 cm) Double Stacked LED Light Bar (270W)	p. 48	\$904.99
			<b>\$10,199.80</b>

\*Note that price does not include installation requirements and that part numbers may vary depending on vehicle model.

EXPLORE

HARD WORK

HUNTING

WINTER

YOU CAN FINANCE THE PURCHASE OF ACCESSORIES with the purchase and financing of your Defender. Ask your dealer for all the details.

YOUR WORK STARTS HERE:  
OUTFIT THE CAN-AM DEFENDER  
TO HAUL, CARRY, AND DO EVEN MORE.



DEFENDER MAX

YOUR ULTIMATE HUNTING RIG  
IS WITHIN REACH—IT'S JUST  
A MATTER OF OUTFITTING  
IT TO YOUR NEEDS.



DEFENDER

## HARD WORK

### STARTER

715003038	Sport Roof	p. 13	\$914.99
715002433	Half Windshield	p. 19	\$294.99
715006316	Half Doors (Max)	p. 22	\$1,764.99
715002423	Deluxe Headache Rack	p. 40	\$459.99
715002464	LinQ Tailgate Extension/Divider	p. 37	\$289.99
			<b>\$3,724.95</b>

### ADVANCED

715005754	Front Bumper	p. 27	\$339.99
715005777	Xtreme Front Bumper Plates	p. 27	\$299.99
715006012	Rear Bumper	p. 29	\$309.99
715002421	Bed Wall Extenders	p. 40	\$919.99
715003665	3.5" (9 cm) Flood LED Lights	p. 49	\$254.99
			<b>\$5,849.90</b>

### PEAK

715006064	LinQ Front Rack	p. 38	\$489.99
715004282	LinQ Low Profile Basket	p. 36	\$209.99
715007077	Rear Cargo Light	p. 51	\$179.99
715004905	Rear View Mirror & Camera Monitor	p. 54	\$539.99
715003095	Overhead Front Audio System	p. 53	\$889.99
715006416	Can-Am HD 4500 Winch	p. 57	\$389.99
			<b>\$8,549.84</b>

\*Note that price does not include installation requirements and that part numbers may vary depending on vehicle model.

## HUNTING

### STARTER

715002430	Sport Roof	p. 13	\$524.99
715002442	Flip Windshield - Hardcoated	p. 19	\$1,099.99
715006314	Half Doors	p. 22	\$1,024.99
715002851	Rear Wind Screen	p. 24	\$119.99
715002423	Deluxe Headache Rack	p. 40	\$459.99
715005466	LinQ Tool & Gun Holder	p. 45	\$529.99
715005449	Hanging Storage Box Kit	p. 39	\$174.99
715005409	Fender Flares	p. 30	\$389.99
			<b>\$4,324.92</b>

### ADVANCED

715005410	Rancher Front Bumper	p. 28	\$644.99
715003879	LinQ 12 Gal (45L) Cargo Box	p. 36	\$284.99
715003870	Adventure Roof Rack	p. 44	\$634.99
			<b>\$5,889.89</b>

### PEAK

715006696	Skid Plate Kit	p. 25	\$1,739.96
715003617	Front Rancher Body Side Protectors	p. 29	\$209.99
715002569	Rock Sliders	p. 31	\$389.99
715002935	4" Round LED Lights	p. 49	\$474.99
715007077	Rear Cargo Light	p. 51	\$179.99
			<b>\$8,884.81</b>

\*Note that price does not include installation requirements and that part numbers may vary depending on vehicle model.



THRIVE IN THE DEEPEST SNOW—FOR WORK OR PLAY. YOUR CAN-AM WAS BORN TO BE A WINTER WARRIOR.



DEFENDER

# WINTER

## STARTER

715002432	Full Windshield - Hardcoated	p. 19	\$694.99
715006325	Soft Doors	p. 22	\$1,219.99
715007081	Rear Polycarbonate Window	p. 23	\$454.99
715005904	Defrost, Heat & Ventilation System	p. 56	\$1,799.99
			<b>\$4,169.96</b>

## ADVANCED

715006821	Fender Flares	p. 30	\$269.99
715003873	Headache Rack	p. 40	\$289.99
715003028	Bed Tool Box	p. 43	\$419.99
715002934	15" (38 cm) Double Stacked LED Light Bar	p. 48	\$474.99
715002456	Light Rack	p. 51	\$194.99
715003665	3.5" (9 cm) Flood LED Lights	p. 49	\$254.99
715004905	Rear View mirror & Camera Monitor	p. 54	\$539.99
715003837	Heated Steering Wheel	p. 56	\$494.99
715006112	Heated Seat Cover (Driver)	p. 56	\$159.99
			<b>\$7,269.87</b>

## TRACKS

715005103	Apache 360LT Tracks	p. 67	\$4,999.99
715005492	Apache 360 LT Tracks Mounting Kit	p. 67	\$679.99
			<b>\$12,949.85</b>

## PLOW

715006111	Warn VRX 45-S Winch	p. 57	\$804.99
715006301	Can-Am ProMount Flex2 72" Plow Kit	p. 70	\$1,369.97
			<b>\$15,124.81</b>

\*Note that price does not include installation requirements and that part numbers may vary depending on vehicle model.

# ROOFS

MADE WITH HIGH-QUALITY MATERIALS DESIGNED IN CONCERT WITH YOUR CAN-AM, OUR ROOFS CREATE A STRONG, LIGHT, RESILIENT BARRIER FROM THE ELEMENTS.



**BUILT FOR YOUR VEHICLE**  
 Engineered with the same design, fit, finish, and built-to-last quality found across our lineup.



**↔ MAKE IT YOURS**

Compatible with other accessories to make your vehicle as unique as you are. Lights, windshield, doors, roofs, bumpers and more.

**100% INTEGRATED**

into the design of all Can-Am accessories.

**EXPERT CHOICE**

**SPORT ROOF**

- Robust injection-molded polypropylene construction.
- Provides added protection for rider and passenger from the elements.

**Defender**  
 715002430  
 \$524.99

**Defender MAX**  
 715003038  
 \$914.99

**DELUXE SPORT ROOF**

- Complete roof kit provides extra driver and passenger protection and also diminishes noise within the cab.
- Perfect fit and finish thanks to the seal kit and the liners included.
- Rear Roof Liner is not compatible with Soft Rear Panel.

**Defender**  
**Kit includes:**  
 • Sport Roof  
 • Sport Roof Seal Kit  
 • Front Roof Liner  
 • Rear Roof Liner  
**715002511**  
**\$1,149.96**

**Defender MAX**  
**Kit includes:**  
 • Sport Roof  
 • Sport Roof Seal Kit  
 • Front Roof Liner  
 • Rear Roof Liner  
**715003039**  
**\$1,809.96**



**SPORT ROOF SEAL KIT**

(Not illustrated)  
 • Necessary when installing individual cab components with Sport Roof or when installing the Front and Rear Roof Liners.

**Defender**  
 715003126  
 \$39.99

**Defender MAX**  
 715003583  
 \$39.99



BIMINI ROOF WITH SUN VISOR

## DESIGN YOUR OWN HARD CAB OR SOFT CAB.

PICK THE ACCESSORIES OF YOUR CHOICE AND BUILD OR COMPLETE YOUR OWN CAB.



100% modular components designed to work together:

- ROOFS** P. 12
- WINDSHIELDS** P. 17
- DOORS** P. 21
- REAR WINDOWS** P. 23



### BIMINI ROOF WITH SUN VISOR

- Heavy-duty canvas made of UV-resistant polyester.
- Soft Top comes with a hard visor that allows for storage of rolled-up soft top and mounting of Light Rack.
- Quick and easy installation.

**Defender**

- Not compatible for use with soft and rigid full doors.
  - 715003418 • Black
- \$389.99**

**Defender MAX**

- 715003030 • Black
- \$634.99**



### FRONT ROOF LINER

- Vehicle enhancement.
- Integrates seamlessly with roof-mounted light switch.
- Required for installation of roof-mounted lights and of the audio systems.
- Allows a better integration of Windshield Wiper & Washer Kit.
- Seal Kit necessary when installing with Sport Roof (715003038 or 715002430).

**Defender, Defender MAX**  
715003098  
**\$259.99**



### REAR ROOF LINER

- Quick and easy vehicle enhancement.
- Allows better integration of other accessories installed on the roof.
- Seal Kit necessary when installing with Sport Roof.

**Defender**

- Needs to be installed with Sport Roof (715002430).
- 715006334  
**\$324.99**

**Defender MAX**

- (Not illustrated)
  - Needs to be installed with Sport Roof (715003038).
- 715006391  
**\$594.99**



### CAB ENCLOSURE

- Rigid cab enclosure ideal for Defender XT vehicles that come stock with a roof, but also fits on Base and DPS models with the addition of a roof.
- Offers good driver and passenger protection from the elements.

**Included:**

- Flip Glass Windshield
- Full Doors with Power Windows
- Rear Window, Insulation Acoustic Kit
- Window Harness
- Roof Power Cable Kit
- Hard Enclosure Roof Seal Kit

**Defender XT**

715006333  
**\$6,259.99**

### PREMIUM RIGID CAB ENCLOSURE

- Provides driver and passenger with the best protection from the elements and the cold, and features the most complete top-of-the-line accessories our product lineup has to offer.
- Not compatible with X mr models.

**Included:**

- Deluxe Sport Roof Kit
- Flip Glass Windshield with Wiper and Washer Kit
- Full Doors with Power Windows
- Rear Glass Window with Sliding Panel
- Thermal Insulation Kit
- Rear Full Doors
- Wiper and Powered Windows Cable
- Roof Power Cable
- Rigid Cab Seal Kit

**Defender MAX**

715006332  
**\$12,179.99**

**Included:**

- Deluxe Sport Roof Kit
- Flip Glass Windshield with Wiper and Washer Kit
- Full Doors with Power Windows
- Rear Glass Window with Sliding Panel
- Thermal Insulation Kit
- Wiper and Powered Windows Cable
- Roof Power Cable
- Rigid Cab Seal Kit

**Defender**

715006330  
**\$7,749.99**





# SOFT CABS



Pick your perfect cab with Can-Am exclusive interchangeable enclosure accessories.

## SOFT CAB ENCLOSURE

- Protection for rider and passenger from the elements.
- Not compatible with X mr models.

- Included:**
- Bimini Roof with Sun Visor (715002918 - Not sold separately / 715003030)
  - Full Windshield - Hardcoated
  - Soft Doors
  - Soft Rear Panel

**Defender (2019 & prior)**

■ 715002917 - Black  
**\$2,399.99**

**Defender (2020 & up)**

■ 715006327 - Black  
**\$2,399.99**

**Defender MAX (2019 & prior)**

■ 715003032 - Black  
**\$3,909.99**

**Defender MAX (2020 & up)**

■ 715006317 - Black  
**\$3,909.99**



## HYBRID CAB ENCLOSURE

(Not illustrated)

- Included:**
- Sport Roof
  - Full Windshield - Hardcoated
  - Soft Doors
  - Rear Polycarbonate Window
  - Rear Wind Protection Installation Seal Kit

**Defender**  
 ■ 715006722 - Black  
**\$2,414.99**

**Defender MAX**  
 ■ 715006723 - Black  
**\$3,749.99**

## CAB INSULATION KIT

(Not illustrated)

- Neoprene insulation kit: A must for cold riding conditions.
- Helps keep the cold outside the cabin and the heat inside when the vehicle is equipped with a complete cab enclosure (soft or rigid).
- Standard on XT Cab models 2018 and up.

**Defender (2019 & prior)**  
 715004911  
**\$124.99**

# WINDSHIELDS

ENHANCE THE FIT, LOOK, AND COMFORT OF YOUR DEFENDER WITH A FACTORY-DEVELOPED WINDSHIELD TO PROTECT FROM THE ELEMENTS, THE DUSTY TRAILS, DEEP MUD HOLES, AND ROCKY TERRAIN.



**MAKROLON® COATING**  
 Our Full Windshield - Hardcoated is made of high-impact-resistant Makrolon® hardcoated polycarbonate to ensure a long life.



## FLIP GLASS WINDSHIELD

Allows you to quickly adapt to changing conditions by adjusting the windshield as you go.



## 100% INTEGRATED

Your Can-Am's standard profiled cage allows our accessories to install easily, with a perfect fit.



**FLIP GLASS WINDSHIELD**

- Curved and laminated glass full windshield in metal frame.
- Provides excellent optical clarity.
- Seals firmly against the cage and protects rider and passenger from the elements while allowing for controlled air flow.
- 3-position flip can be set at fully closed, ¼ open, or fully open.

- Gas-shock-assisted operation and pivots on 2 hinges located at the top of the windshield.
- Ideal for muddy conditions.
- Can be used with Windshield Wiper & Washer Kit (715001638).
- Not EC compliant.

**Defender, Defender MAX**  
715002942  
\$1,529.99

**FLIP WINDSHIELD – HARDCOATED**

- High-impact-resistant Makrolon<sup>1</sup> hardcoated polycarbonate full windshield in metal frame.
- Provides excellent optical clarity and better abrasion resistance.
- Seals firmly against the cage and protects rider and passenger from

- the elements while allowing for controlled air flow.
- 3-position flip can be set at fully closed, ¼ open, or fully open.
- Gas-shock-assisted operation.
- Ideal for muddy conditions.

**Defender, Defender MAX**  
715002442  
\$1,099.99



**GLASS WINDSHIELD**

- Curved and laminated glass full windshield in metal frame.
- Seals firmly against the cage and protects rider and passenger from the elements while providing excellent optical clarity.

- Must be used with Windshield Wiper & Washer Kit (715001638) to maintain clear visibility during severe riding conditions.
- Not EC compliant.

**Defender, Defender MAX**  
715001303  
\$1,154.99



**FLIP GLASS WINDSHIELD WITH WIPER & WASHER KIT**

- Curved and laminated glass full windshield in metal frame.
- Provides excellent optical clarity.
- Seals firmly against the cage and protects rider and passenger from the elements while allowing for controlled air flow.
- Flip windshield can be set fully closed or fully open according to your preference.

- Ideal for muddy conditions.
- Gas-shock-assisted operation and pivots on 2 hinges located at the top of the windshield.
- Single-speed wiper with washer fluid dispenser.
- Requires Wiper & Power Cable (710004462) and Power Cable (715003094).
- Not EC compliant.

**Defender, Defender MAX**  
715002441  
\$2,114.99

**WINDSHIELD WIPER & WASHER KIT**

- An ideal way to keep your windshield clear in rain, or while riding through mud and water.
- Includes single-speed wiper, washer fluid dispenser and windshield frame mount.
- Must be used with the Glass Windshield (715001303) or Flip Glass Windshield (715002942).
- Requires Wiper & Power Windows Cable (710004462) and Power Cable (715003094).
- Not EC compliant.

**Defender, Defender MAX**  
715001638  
\$709.99



**WIPER & POWER WINDOWS CABLE**

- (Not illustrated)
- Required to install Full Doors with Power Windows (715006331) and/or Windshield Wiper & Washer Kit (715001638).
- Necessary if you want to build your own cab enclosure from modular components.

**Defender, Defender MAX**  
710004462  
\$77.99

**FULL WINDSHIELD – HARDCOATED**

- High-impact-resistant Makrolon<sup>1</sup> hardcoated polycarbonate full windshield.
- Provides excellent optical clarity and better abrasion resistance.
- Protects driver and passenger from the elements.
- Quick and easy tool-less installation or removal.

**Defender, Defender MAX**  
715002432  
\$694.99



**FULL WINDSHIELD**

- High-impact-resistant durable polycarbonate full windshield.
- Formulated to be non-yellowing, non-crazing, non-cracking with excellent UV resistance and optical clarity.
- Protects driver and passenger from the elements.
- Quick and easy tool-less installation or removal.

**Defender, Defender MAX**  
715002431  
\$464.99



**HALF WINDSHIELD**

- High-impact-resistant durable polycarbonate half windshield.
- Formulated to be non-yellowing, non-crazing, non-cracking with excellent UV resistance and optical clarity.
- Protects driver and passenger from the elements.
- Features reverse angle lip to deflect air flow.
- Quick and easy tool-less installation or removal.
- Not compatible with Soft Doors.

**Defender, Defender MAX**  
715002433  
\$294.99





SIDE WIND DEFLECTORS



ENHANCED UTILITY, LOOKS, AND PROTECTION FROM THE ELEMENTS ON JOBSITES AND TRAIL RIDES ALIKE.

**EXPERT CHOICE**

**PROVENT WINDSHIELD**

- High-impact-resistant Quantum<sup>1</sup> hardcoated polycarbonate full windshield.
- Optimal performance with Full Cab Enclosure.
- Controllable vents to manage air flow.
- Channels air into the cabin, defogs windshield, fully closes to eliminate air flow.
- 2 lower vents and one upper vent (pre-filter installed).
- Provides excellent optical clarity and better abrasion resistance.
- Protects driver and passenger from the elements.
- Quick and easy tool-less installation or removal.
- Not compatible with wiper kits.

**Defender, Defender MAX**  
715005276  
\$944.99

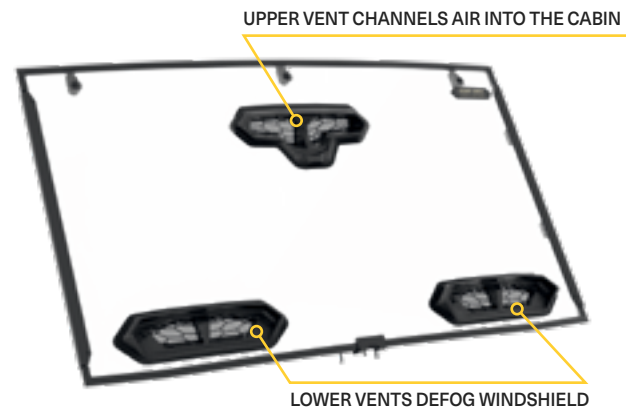

**SIDE WIND DEFLECTORS**

- Clear polycarbonate air deflectors mount on each side of the cage.
- Not compatible with Full Doors.
- Sold in pairs.
- Compatible with all windshields.

**Defender, Defender MAX**  
715005081  
\$219.99

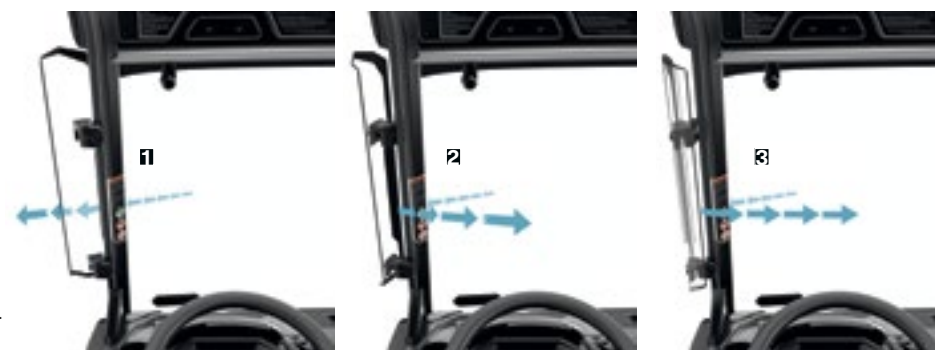

- Can be adjusted at three different positions for cabin air flow control when a full windshield is installed:
- 1. Outside deflection to reduce cabin air flow and turbulence.
- 2. Inside deflection to increase air flow in the cabin.
- 3. Windshield ventilation to reduce fog.

**SIDE MIRROR**

- Molded heavy-duty aluminum mirror.
- Stays in place on rough trails.
- Ball-joint design for steady multi-angle adjustment and outstanding vision.
- Can be used with or without roof, windshield or door.
- Not for road use.
- Fits either side.
- Sold individually.

**Defender, Defender MAX**  
715002459  
\$124.99



**PANORAMIC CENTER MIRROR**

- Wide-angle convex mirror.
- Offers enhanced visibility.
- Can be used with or without roof or windshield and with cab enclosures.

**Defender, Defender MAX**  
715003638  
\$104.99



**TOOL-LESS REMOVABILITY**  
Once installed, our doors are easy to remove on hot and sunny days.

**100% INTEGRATED**  
Your Can-Am's standard profiled cage allows our accessories to install easily, with a perfect fit.

**FULL DOORS WITH POWER WINDOWS**

- Made from robust high-density polyethylene.
- Offer excellent protection from the elements.
- Easy to remove on hot and sunny days.
- Lockable doors with convenient integrated storage areas.
- Doors' curved design provides even more roominess.
- Rear hinge wide opening for ease of ingress/egress in the cockpit.
- Power window delivers added ventilation.
- Compatible with all BRP windshields.
- Require Wiper & Power Windows Cable (710004462), Roof Power Cable (715003094) and Seal Kit (715003126).

**Defender, Defender Max**  
**715006331**  
**\$4,644.99**



**REAR FULL DOORS**

- Made from robust high-density polyethylene.
- Offer excellent protection from the elements.
- Easy to remove on hot and sunny days.
- Lockable doors with convenient integrated storage areas.
- Curved design provides even more roominess.
- Rear hinge opens wide for ease of ingress/egress in the cockpit.
- Pop-out window delivers added ventilation.
- Require Front Doors (715006331), Wiper and Power Windows Cables (710004462), Power Cable (715003094) and Sport Roof Seal Kit (715003583).

**Defender MAX**  
**715006329**  
**\$4,299.99**



**HALF DOORS**

- Half doors made of plastic.
- Metal frame for a higher level of fit and finish and rigidity.
- Rear hinge wide opening for ease of ingress/egress in the cockpit.
- Interior pockets and liners for more protection.

**Defender (2 doors)**  
**715006314**  
**\$1,024.99**

**Defender MAX (4 doors)**  
**715006316**  
**\$1,764.99**



REAR GLASS WINDOW

**SOFT DOORS**

- Bestop designed soft doors for Can-Am Defender.
- Weather-resistant soft doors reinforced with steel frame offer good protection from the elements.
- Made of heavy-duty UV-resistant canvas for excellent resistance to tear and abrasion.
- Rear hinge wide opening for ease of ingress/egress.
- Zip-down windows made of laminated polished vinyl material for added ventilation.
- Easily removable on hot sunny days.
- Compatible with roofs and mirrors.
- Soft Door Installation Kit (715006238 / 2X for MAX) is required for installation of 2019 & prior doors, on 2020 Defender models.

**Defender, Defender MAX**  
**(Front passenger door only)**  
 ■ 715006676 · Black  
**\$669.99**



**Defender (2 doors)**  
 ■ 715006325 · Black  
**\$1,219.99**



**Defender MAX (4 doors)**  
 ■ 715006322 · Black  
**\$2,429.98**

**REAR WIND PROTECTION**

**REAR GLASS WINDOW WITH SLIDING PANEL**

- Made of high-strength tempered glass.
- Ideal for preventing backdraft of dust or rain in harsh environments.
- Sliding panel for enhanced ventilation.
- Quick and easy installation.
- Sport Roof (715002430 or 715003038) required for installation.
- Not compatible with snorkel kit.

**Defender, Defender MAX (except X mr models)**  
**715007080**  
**\$909.99**



**REAR GLASS WINDOW**

- Made of high-strength tempered glass.
- Ideal for preventing backdraft of dust or rain in harsh environments.
- Quick and easy installation.
- Sport Roof (715002430 or 715003038) required for installation.
- Not compatible with snorkel kit.

**Defender, Defender MAX (except X mr models)**  
**715007079**  
**\$589.99**



**REAR POLYCARBONATE WINDOW**

- High-impact-resistant polycarbonate window.
- Ideal for preventing backdraft of dust or rain in harsh environments.
- Quick and easy installation.
- Sport Roof (715002430 or 715003038) required for installation.
- Not compatible with snorkel kit.

**Defender, Defender MAX (except X mr models)**  
**715007081**  
**\$454.99**



SOFT REAR SCREEN



**SOFT REAR PANEL**

- Weather-resistant soft rear panel with steel frame offers good protection from the elements.
- Made of heavy-duty UV-resistant canvas for excellent resistance to tear and abrasion.
- Tinted window made of laminated polished vinyl material.
- Resists cold cracking to -22 °F (-30 °C).
- Installs quick and easily on roll cage.
- Not compatible with the Bimini Roof with Sun Visor

**Defender, Defender MAX (2019 & prior)**

715002920 • Black  
\$259.99

**Defender, Defender MAX (2020 & up)**

NEW 715006680 • Black  
\$259.99



**REAR WIND SCREEN**

- Full rear mesh screen reduces windshield backdraft for added cabin comfort.
- Installs quick and easily on roll cage.
- White Can-Am logo at top, to help maintain clear view.

**Defender, Defender MAX**

715002851  
\$119.99

**SOFT REAR WINDOW**

- Clear, flexible window made of see-through vinyl.
- Resists cold cracking to -4 °F (-20 °C).
- Blocks windshield backdraft or dust and rain from entering, for added cabin comfort.
- Installs quick and easily on roll cage.
- White Can-Am logo at top, to help maintain clear view.

**Defender, Defender MAX**

715003249  
\$134.99

# ALUMINUM SKID PLATES

For ultimate durability and strength, all our Aluminum Skid Plates are made with High Strength 5052 H32 Aluminum 3/16" (4.5 mm) thick.

- ✓ Ultimate durability
- ✓ High strength

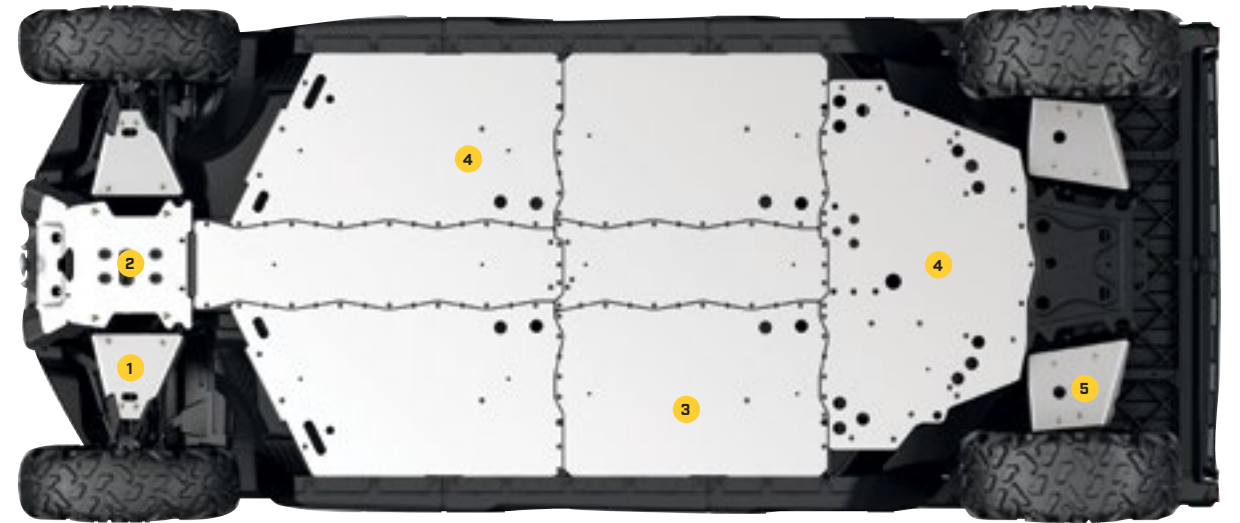

**DEFENDER, DEFENDER MAX**

2019 & PRIOR		2020 & UP		
Base, DPS, XT, XT-P, XT Cab 2017 & prior & Hunting Edition	XT Cab 2018-2019, Lonestar Edition & X mr	Base, DPS (HD5 & HD8), XT (HD8) & PRO (HD8)	6x6 (DPS & XT) or Pro (DPS, XT), XT PRO, DPS (HD10), XT (HD10) & XT-P	XT Cab, Hunting Edition, Lonestar Edition, Limited, & X mr

**FULL PROTECTION KIT**

	2019 & PRIOR	2019 & PRIOR	2020 & UP	2020 & UP	2020 & UP
ALUMINUM SKID PLATE PROTECTION KIT	715003711 (except MAX) \$1,614.96	715006977 (3up) \$1,812.94	715006694 (except MAX) \$1,609.96	715006696 (3up & 6x6) \$1,739.96	715006979 (3up) \$1,807.94
	715003712 (MAX only) \$2,109.95	715006978 (MAX) \$2,307.93	715006695 (MAX only) \$2,104.95	715006697 (MAX & PRO) \$2,234.95	715006980 (MAX) \$2302.93

**INDIVIDUAL ALUMINUM SKID PLATES**

	2019 & PRIOR	2019 & PRIOR	2020 & UP	2020 & UP	2020 & UP
<b>1</b> FRONT A-ARM PROTECTORS • Extra underside protection for your vehicle's steering mechanism and suspension (A-Arm). • Sold in pairs. • Not compatible with Apache Track Systems.	715002444 \$189.99	715006975 \$228.98	715002444 \$189.99	715004387 \$194.99	715006975 \$228.98
<b>2</b> FRONT SKID PLATE • Protects the front underside of your vehicle when riding in rough terrain conditions. • Adds style to the front of your vehicle.	715002447 \$244.99	715002447 \$244.99	715002447 \$244.99	715002447 \$244.99	715002447 \$244.99
<b>3</b> CENTRAL SKID PLATE • Central skid plate kit includes central and lateral skid plates. • Ultra-durable protection for the underside of your vehicle. • Makes work easy in more demanding terrain. • Must be used with Underbelly Skid Plate Kit.	715003467 (MAX only) \$494.99	715003467 (MAX only) \$494.99	715003467 (MAX only) \$494.99	715003467 (MAX & PRO only) \$494.99	715003467 (MAX only) \$494.99
<b>4</b> UNDERBELLY SKID PLATE KIT • Ultra-durable protection for the underside of your vehicle. • Makes work easy in more demanding terrain. • Kit includes lateral and rear skid plates.	715002446 \$984.99	715002446 \$984.99	715006197 \$979.99	715006197 \$979.99	715006197 \$979.99
<b>5</b> REAR A-ARM PROTECTORS • Extra underside protection for your vehicle's suspension (A-Arm). • Sold in pairs. • Not compatible with Apache Track Systems.	715002445 \$194.99	715006976 \$353.98	715002445 \$194.99	715004388 \$319.99	715006976 \$353.98

# BUMPERS

THE STRENGTH TO ENDURE AND THE CHARACTER TO WEAR WELL—OUR BUMPERS ARE READY FOR IT.



HEAVY-DUTY LOOKS REAL CAPABILITY—WITH A DURABLE FIT AND FINISH YOU'LL JUST HAVE TO AGE YOURSELF

**BETTER CORROSION PROTECTION**  
Can-Am bumpers are E-Coated for supreme corrosion protection inside and out.



**BUILT FOR BIG LIGHTS**

Fully integrated bumper mounting plate gives rigid mounting and solid protection for multiple accessory lights.



**100% INTEGRATED**

Designed to seamlessly integrate with the style, fit, finish, and capability of your Defender.



**EXPERT CHOICE**

**FRONT BUMPER**

- Heavy-duty 1.5" (3.8 cm) diameter steel-tube construction.
- Provides enhanced protection.
- Inside and outside anti-corrosion coating with durable powder coat finish.

**Defender, Defender MAX (2019 & prior)**  
715002418  
\$289.99

- Integrated mounting points for lights.
- Required to install the Xtreme Front Bumper Plates, Front Rack and the Front Corner Protectors.

**Defender, Defender MAX (2020 & up)**  
715005754  
\$339.99



**XTREME FRONT BUMPER PLATES**

- Made of high-strength heavy-gauge steel with rubber pads for increased protection.
- Inside and outside anti-corrosion coating with durable powder coat finish.
- Provide additional front-end protection.

**Defender, Defender MAX (2019 & prior)**  
• Require Front Bumper (715002418) for installation.  
715003005  
\$244.99

**Defender, Defender MAX (2020 & up)**  
• Require Front Bumper (715005754) for installation.  
715005777  
\$299.99



**FRONT CORNER PROTECTORS**

- Heavy-duty 1.25" (3.2 cm) diameter steel-tube construction.
- Provide enhanced protection for front corners.
- Inside and outside anti-corrosion coating with durable powder coat finish.
- Sold in pairs.

**Defender, Defender MAX (2019 & prior)**  
• Require Front Bumper (715002418) for installation.  
715002833  
\$209.99

**Defender, Defender MAX (2020 & up)**  
• Require Front Bumper (715005754) for installation.  
715005774  
\$219.99



715005774



**RANCHER FRONT BUMPER**

- The low front-end protection and plates allow you to use your vehicle within cattle herds and guard the safety of both the vehicle and the animals.
- The flat front portion facilitates gently prodding cattle or pushing light objects, e.g., closing a fence.
- The full frontage coverage extends to provide an extra layer of defense to your headlights and radiator.
- Inside and outside anti-corrosion coating with durable powder coat finish.

**Defender, Defender MAX (2019 & prior)**  
 715002834  
**\$589.99**

**Defender, Defender MAX (2020 & up)**  
 • Improved approach angle.  
 • Compatible with front rack, snow plows, tire and track kits, winches.  
 715005410  
**\$644.99**



715002834



715005410

**XT FRONT BUMPER**

- 1.5" (3.8 cm) diameter steel-tube construction.
- Provides light-duty protection.
- Inside and outside anti-corrosion coating with durable powder coat finish.
- Light-kit compatible.
- Standard on XT and XT Cab models 2018 and 2019.
- Not compatible with Xtreme Front Bumper Plates, Front Corner Protectors and LinQ Front Rack.

**Defender, Defender MAX (2019 & prior)**  
 715004407  
**\$209.99**



**XT-P FRONT BUMPER**

- Heavy-duty 1.5" (3.8 cm) diameter steel-tube construction.
- Inside and outside anti-corrosion coating with durable finish.
- Provides additional front body protection.
- Integrated mount plate for auxiliary light installation.
- Winch Support Plate (705206371) is required for winch relocation at a higher position for easier access in muddy conditions (sold separately).
- Standard on XT-P models.

**Defender, Defender MAX (2019 & prior)**  
 ■ 715004408 · Can-Am Red  
**\$294.99**

**Defender, Defender MAX**  
 ■ 715006145 · Silver  
**\$294.99**



**X MR FRONT BUMPER**

- Heavy-duty 1.5" (3.8 cm) diameter steel-tube construction.
- Inside and outside anti-corrosion coating with durable finish.
- Provides additional front body protection.
- Integrated winch support plate for winch relocation at a higher position for easier access in muddy conditions or for auxiliary lights.
- Includes a front tow hook.
- Standard on X mr models.
- Winch sold separately.

**Defender, Defender MAX (2019 & prior)**  
 ■ 715004405 · Black  
**\$339.99**

■ 715004406 · Sunburst Yellow  
**\$369.99**

**Defender, Defender MAX (2020 & up)**  
 ■ 715006143 · Black  
**\$339.99**

■ 715006144 · Green  
**\$369.99**



**CARGO BED PROTECTORS & TIE RAILS**

- Heavy-duty 1.5" (3.8 cm) diameter steel-tube construction.
- Reliable cargo box protection and tie-down attachment point to secure large loads.
- Anti-corrosion coating with durable powder coat finish.
- Designed to stay in place when cargo bed side walls are removed.

**Defender 6x6 & PRO models**  
 715005415  
**\$339.99**

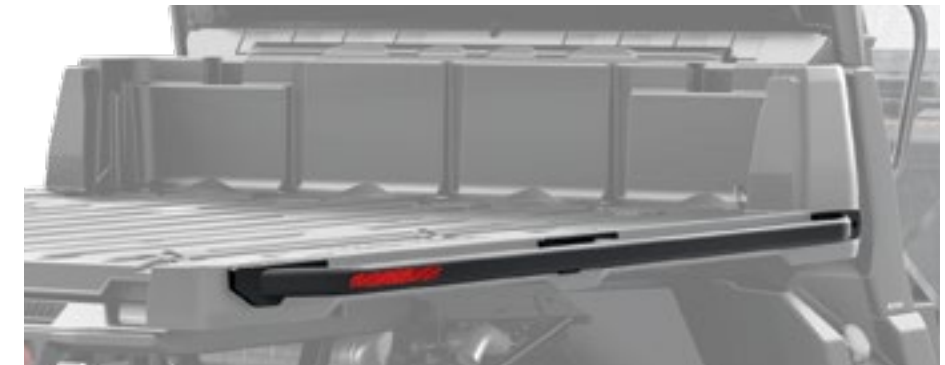

**FRONT BODY SIDE PROTECTORS**

- Heavy-duty 1.25" (3.2 cm) diameter steel-tube construction.
- Front side protection for farm, ranch and forestry applications.
- Offer complete front body protection.
- Inside and outside anti-corrosion coating with durable powder coat finish.
- Sold in pairs.

**FRONT BODY SIDE PROTECTORS**

- Require Front Bumper (715002418 or 715005754) with Front Corner Protectors (715002833 or 715005774) and Rock Slider (715002569 or 715003040 for MAX models) for installation.

**Defender, Defender MAX**  
 715003450  
**\$164.99**

**FRONT RANCHER BODY SIDE PROTECTORS**

- Require Rancher Bumper (715002834/715005410) and Rock Sliders (715002569 or 715003040 for MAX models) for installation.

**Defender, Defender MAX**  
 715003617  
**\$209.99**

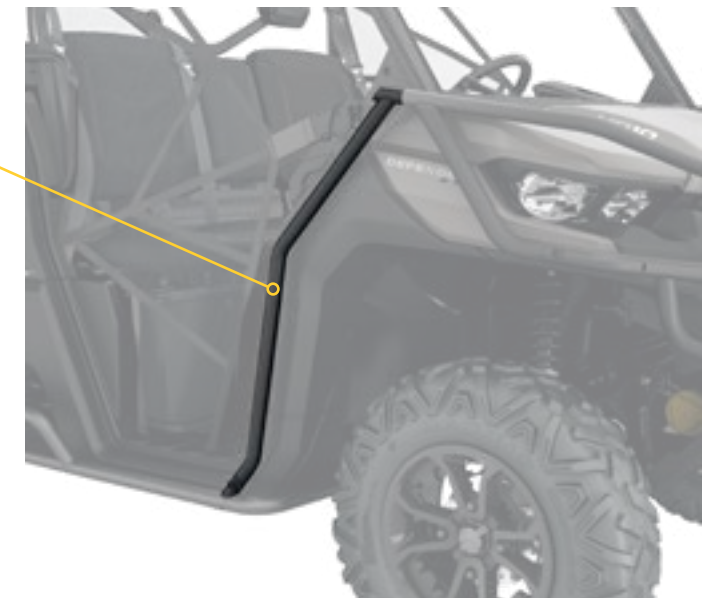

**REAR BUMPER**

- Heavy-duty 1.5" (3.8 cm) diameter steel construction and integrated tubular design.
- Increased protection of rear box and lower box corner while allowing normal tailgate function.
- Anti-corrosion coating with durable powder coat finish.
- Required to install Rear Body Side Protector (715003055).
- Rear bumper Adapter (715006060) is required for installation on the Defender 6x6 & PRO models.

**Defender, Defender MAX**  
 715006012  
**\$309.99**



**REAR BUMPER ADAPTER**

- (Not illustrated)
- Required to install the Rear Bumper on Defender models with the long box.

**Defender 6x6 & PRO models**  
 715006060  
**\$51.99**

**REAR BODY SIDE PROTECTORS**

- Heavy-duty 1.5" (3.8 cm) diameter steel-tube construction.
- Reliable cargo box protection.
- Inside and outside anti-corrosion coating with durable powder coat finish.
- Compatible with fender flares.
- Integrated brush and low-lying branch deflector.
- Require Rear Bumper (715006012 or 715002419) for installation.
- Sold in pairs.

**Defender, Defender MAX (except 6x6 & PRO)**  
 715003055  
**\$219.99**





AGGRESSIVELY PROFILED TO KEEP MUD, DEBRIS, AND SNOW OUTSIDE THE VEHICLE.



**FENDER FLARES**

- Robust injection-molded polypropylene construction.
- Perfect for keeping mud and debris outside the vehicle.
- Include front and rear extension, and all mounting hardware.
- Ideal for track equipped vehicles.

<b>Defender (except 6x6 &amp; PRO)</b> 715006821 \$269.99	<b>Defender 6x6</b> 715005409 \$389.99	<b>Defender PRO</b> 715006001 \$329.99
---	--	--

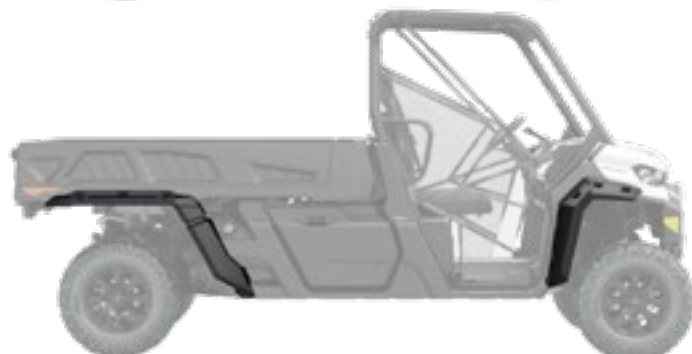

**SPORT FENDER FLARES**

- Sleek fender flares just the right size to reduce mud and debris kick-up from your tires.
- Robust injection-molded polypropylene construction.
- Include front and rear extension, and all mounting hardware.

**Defender (except 6x6 & PRO), Defender MAX**  
715003898  
\$264.99



**ROCK SLIDERS**

- Heavy-duty rock sliders made of painted 3/16" (5 mm) aluminum with an integrated step for elevated cargo box access.
- Protect vehicle's sides and undercarriage against large obstacles.
- Lodge tight up against vehicle body for better clearance from obstacles.
- Not compatible with other rock sliders.
- Sold in pairs.
- Standard on Defender X mr, Defender MAX X mr and Defender XT-P models.

**Defender (2019 & prior)**  
715004409 · Black  
\$494.99

**Defender MAX (2019 & prior)**  
715005020 · Black  
\$739.99

**Defender (2020 & up)**  
715006671 · Black  
\$494.99

**Defender (2020 & up)**  
715006675 · Manta Green  
715006672 · Red  
715006674 · Silver  
715006673 · Yellow  
\$519.99

**Defender MAX 2020 & Defender PRO**  
715006721 · Black  
\$739.99

**ROCK SLIDERS**

- Protect vehicle's sides and undercarriage against large obstacles.
- Made of heavy-duty 1.5" (3.8 cm) diameter steel tubing.
- Inside and outside anti-corrosion coating with durable powder coat finish.
- Integrated step for easy cargo box access.
- Sold in pairs.

**Defender, Defender 6x6**  
715002569 · Black  
\$389.99

**Defender MAX, Defender PRO**  
715003040 · Black  
\$474.99



715006675



**MUD FLAPS**

- Keep mud and debris out of cargo area and protect trailer or vehicles behind you.
- Add aesthetic appeal to your vehicle.
- Made of EPDM rubber.
- Require Rear Bumper (715006012 or 715002419) for installation.
- Sold in pairs.

**Defender, Defender MAX**  
715003041  
\$164.99





WHEN IT COMES TO MUD-MASTERING ACCESSORIES, S3 HAS THE EDGE IN DELIVERING PERFECT-FIT WINCH-READY BUMPERS FOR WORK, PLAY, AND RECOVERY.



Closed course dedicated for mud riding.

**S3 FRONT WINCH BUMPER**

- Made of 1.5" (3.8 cm) diameter steel tubing with durable powder coat finish.
- Specifically developed for mud riding enthusiasts.
- Integrated mounting plates accommodate all winches.
- Allows higher winch position to avoid winch immersion in mud.
- Added body protection.
- Not compatible with LinQ Front Rack, Removable Winch Mounting Kit, Super-Duty Plow Push Frame Extension and Plow Pulley.
- "S3 for Can-Am" branded.
- Winch not included.

**Defender, Defender MAX (2019 & prior)**

- 715003779 · Black
  - 715005092 · Sunburst Yellow
- \$739.99**



**S3 REAR WINCH BUMPER**

- Made of 1.5" (3.8 cm) diameter steel tubing with durable powder coat finish.
- Specifically developed for mud riding enthusiasts.
- Integrated mounting plates for winches and towing anchor points.
- Added body protection.
- Not compatible with Apache 360 LT Track System and Removable Winch Mounting Kit.
- Compatible with Defender winches (Rear Winch Electrical Harness required).
- "S3 for Can-Am" branded.

**Defender, Defender MAX (2019 & prior)**

- 715003782 · Black
  - 715005123 · Sunburst Yellow
- \$739.99**



**REAR WINCH ELECTRICAL HARNESS**

- (Not illustrated)
- Required for the installation of a winch on the S3 Rear Winch Bumper.
  - Compatible with complete Defender winch lineup.

**Defender, Defender MAX (2019 & prior)**

- 715004233
- \$219.99**

**S3 NERF BARS**

- Made of 1.5" (3.8 cm) diameter steel tubing with durable powder coat finish.
- Specifically developed for mud riding enthusiasts.
- Protect vehicle's lower sides without affecting ground clearance.
- Integrated step makes ingress easier.
- Not compatible with Front Body Side Protectors, Front Rancher Body Side Protectors and Apache 360 LT Track System.
- "S3 for Can-Am" branded.

**Defender, Defender 6x6**

- 715003783 · Black
  - 715005094 · Sunburst Yellow
- \$519.99**

**Defender MAX, Defender PRO**

- 715004349 · Black
- \$729.99**

- 715005124 · Sunburst Yellow
- \$709.99**



EASY ON, EASY OFF CARGO



A BRP EXCLUSIVE, LinQ IS A TOOL-LESS SYSTEM FOR NEAR-INSTANT INSTALLATION OF ACCESSORIES. QUICKLY, EASILY INSTALL AND REMOVE LinQ ACCESSORIES TO TRANSFORM YOUR MACHINE TO FIT THE MOMENT.

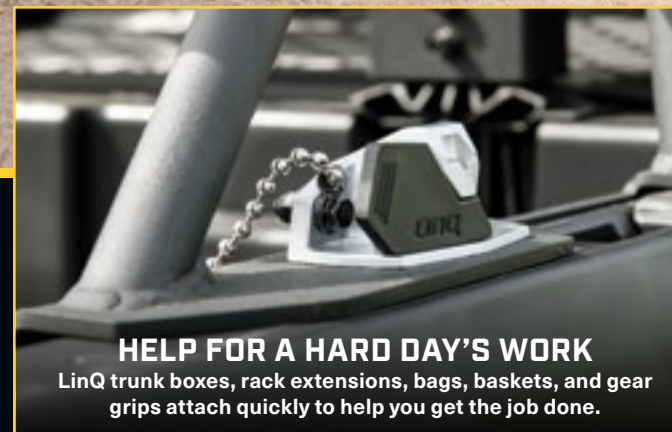

**HELP FOR A HARD DAY'S WORK**

LinQ trunk boxes, rack extensions, bags, baskets, and gear grips attach quickly to help you get the job done.

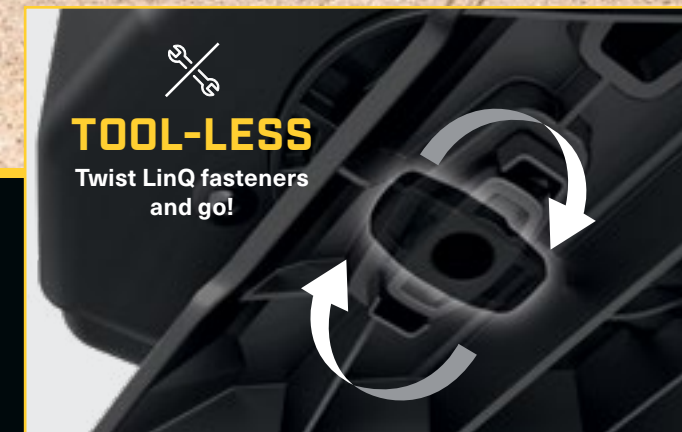

**TOOL-LESS**

Twist LinQ fasteners and go!

**LinQ ACCESSORY TYPES**

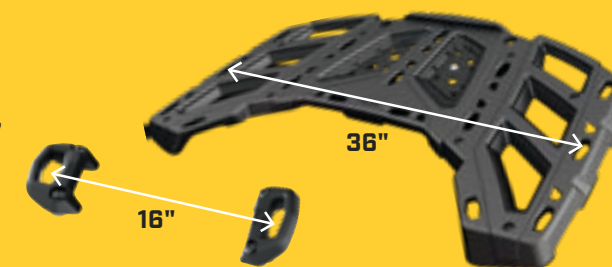

- LinQ with 16" base accessories are mounted with LinQ anchors 16 inches apart, ideal for Can-Am ATVs and SSVs, Sea-Doo watercraft, and Ski-Doo snowmobiles.
- LinQ with 36" base accessories are most commonly used as part of LinQ racks for Can-Am Off-Road vehicles.



# LinQ SYSTEM™ ACCESSORIES





- No tools needed: Quickly install and remove accessories by hand
- Equip your Can-Am for specialized tasks in no time
- Sturdy mounting system that holds up to the roughest terrain

## MOUNTING LOCATION AND REQUIREMENTS

<b>CARGO BED</b> (long box bed LinQ) 	<b>LinQ CARGO RACK</b> 715006140 	<b>ADVENTURE ROOF RACK</b> 715003870 / 715004391 
--	--	--







- LinQ anchors mounted 16 inches apart, center-to-center.
- Lower loading capacity than the LinQ with 36" base accessories.
- Can be used on Can-Am ATV and SSV vehicles, Sea-Doo watercraft and Ski-Doo snowmobiles.

### LinQ ACCESSORIES WITH 16" BASE p. 35

 <b>LinQ 4.2 GAL (16 L) COOLER</b> 295100698	<b>LinQ Cargo Base Kit</b> 860201806 + <b>LinQ Base Installation Kit</b> 860201812	<b>LinQ Cargo Base Kit</b> 860201806	Not compatible
 <b>LinQ TOOL BOX</b> 715004301	<b>LinQ Base Installation Kit</b> 860201812	No further requirements	No further requirements
 <b>LinQ SR 5.5 GAL (21 L) BAG</b> 860201740			
 <b>LinQ 4.5 GAL (17 L) SPORT BAG</b> 860201678			
 <b>LinQ DRY BAG</b> 715002875			

### LinQ ACCESSORIES WITH 36" BASE p. 36

- Mount on LinQ racks often used by Can-Am ORV vehicles.
- Higher loading capacity than the LinQ with 16" base accessories.
- Usage is limited to Can-Am ORV vehicles.

 <b>LinQ 12 GAL (45L) CARGO BOX</b> 715003879	Not compatible	No further requirements	No further requirements	
 <b>LinQ 23 GAL (86L) TRUNK BOX</b> 715004923				
 <b>LinQ 11.5 GAL (43L) AUDIO CARGO BOX</b> 715003018				
 <b>LinQ 8 GAL (30L) COOLER BOX</b> 715004778 • Black / 715004698 • Grey			Not compatible	
 <b>LinQ PREMIUM STORAGE BAG BY OGIO</b> 715002923 • Black / 715003248 • Camo				
 <b>LinQ HEAVY-DUTY BASKET</b> 715001215				No further requirements
 <b>LinQ LOW PROFILE BASKET</b> 715004282				

### LinQ RACKS & HOLDERS p. 41

 <b>LinQ TOOL HOLDER</b> 715003059	No further requirements	No further requirements	Side wall installation: <b>LinQ Adapters</b> 715003058
--	-------------------------	-------------------------	--



EQUIP YOUR DEFENDER FOR ADDED CARGO CAPACITY.

LinQ DRY BAG

### LinQ Accessories with 16" base

#### EXPERT CHOICE

#### LinQ 4.2 GAL (16 L) COOLER

- LinQ-mounted weather-resistant 4.2 Gal (16 L) cooler.
- Rotomolded construction for exceptional rigidity and durability.
- Premium-quality foam insulation for optimal ice retention.
- Sea-doo: marinized LinQ for salt water uses.

See table for installation location and requirements.

**Defender, Defender MAX**  
295100698  
**\$369.99**



#### LinQ TOOL BOX

- High precision injected HDPE construction provides rigidity and durability.
- 5 Gal (19 L) maximum capacity.
- Weather-resistant, sealed and lockable cover.
- Sea-doo: marinized LinQ for salt water uses.

See table for installation location and requirements.

**Defender, Defender MAX**  
715004301  
**\$179.99**



#### LinQ SR 5.5 GAL (21 L) BAG

- Semi-rigid expandable bag.
- 5.5 Gal (21 L) capacity.
- LinQ Cargo Base Kit (860201806) included.

See table for installation location and requirements.

**Defender, Defender MAX**  
860201740  
**\$224.99**



#### LinQ 4.5 GAL (17 L) SPORT BAG

- 4.5 Gal (17 L) capacity.
- Rigid bottom, semi-rigid top.

See table for installation location and requirements.

**Defender, Defender MAX**  
860201678  
**\$204.99**



#### LinQ DRY BAG

- Fully waterproof roll-top dry bag will securely store and confine your equipment.
- LinQ mounted using heavy-duty rigid plastic base.
- High capacity storage solution (40L).
- Bottom foam liner for additional equipment protection.
- Integrated handle for easy transportation on/off the vehicle.
- LinQ Cargo Base Kit (860201806) included.
- Sea-doo: marinized LinQ for salt water uses.

See table for installation location and requirements.

**Defender, Defender MAX**  
715002875  
**\$234.99**



LinQ Accessories with 36" base 

**LINQ 12 GAL (45 L) CARGO BOX**

- Holds cargo safely and securely while riding.

See table for installation location and requirements.  
**Defender, Defender MAX**  
 715003879  
**\$284.99**



**LINQ 23 GAL (86 L) TRUNK BOX**

- Lockable and weather-resistant.
- Holds cargo safely and securely while riding.

See table for installation location and requirements.  
**Defender, Defender MAX**  
 715004923  
**\$354.99**



**LINQ 11.5 GAL (43 L) AUDIO CARGO BOX**

- An affordable and quick solution for adding music and storage to your next ride. The rear installation does not use up any cab space and allows easy listening at an average speed.
- Mounts on/off easily to hold/carry cargo safely and securely.
- The Bluetooth enabled receiver and 6.5" (16.5 cm) speakers are smartly concealed and integrated in the cover.
- Automatic shut-off function protects your battery by turning the system off after 10 minutes of inactivity.
- Backlit control panel perfect for night riding.
- Water-resistant speakers.

See table for installation location and requirements.  
**Defender, Defender MAX**  
 715003018  
**\$694.99**



**LINQ 8 GAL (30 L) COOLER BOX**

- Installs without vehicle modification.
- Rotomolded construction provides exceptional rigidity and durability.
- Premium-quality foam insulation for optimal ice retention.
- Integrated, fully-removable compartment protects food.
- Robust rubber latches keep the cover tightly closed.
- Weather-resistant.
- Convenient drain plug.

See table for installation location and requirements.  
**Defender, Defender MAX**  
 715004698 - Grey  
 715004778 - Black  
**\$459.99**



**LINQ PREMIUM STORAGE BAG BY OGIO**

- 17.2 Gal (65 L) capacity semi-rigid cargo bag ideal for carrying anything you need on your vehicle.
- Buckle and elastic closure with a rubber seal that protects dust from entering the bag.
- 3-section lid for partial or full access to your bag.
- Inside separators for optimal bag organization.

See table for installation location and requirements.  
**Defender, Defender MAX**  
 715002923 - Black  
**\$499.99**

715003248 - Mossy Oak Break-Up Country Camo  
**\$579.99**



Inside separators for optimal bag organization

**LINQ HEAVY-DUTY BASKET**

- Made of high-strength, low-alloy steel.

See table for installation location and requirements.  
**Defender, Defender MAX**  
 715001215  
**\$269.99**



**LINQ LOW PROFILE BASKET**

- Low profile, open basket increases cargo space.
- Perfect for easy access to tools, rope, winch and plow accessories.
- Multiple bungee cord and tie-down anchor points.
- Made of impact-resistant injected polypropylene.

See table for installation location and requirements.  
**Defender, Defender MAX**  
 715004282  
**\$209.99**



**EXPERT CHOICE**

**LINQ TAILGATE EXTENSION FOR LONG BOX**

- Adds rear cargo capacity when the tailgate is open.
- Steel-tubing-system-style barrier mounts on top of the bed walls using the easy, tool-less LinQ System.
- Can be mounted to serve as cargo divider at different locations along the bed wall while preventing larger items from falling off the back.
- Stores neatly out of the way and offers additional cab area protection since it can be mounted upside down on the front bed wall as a mini headache rack.
- Inside and outside anti-corrosion coating with durable powder coat finish.

**Defender, Defender MAX (except 6x6 and PRO models)**  
 715002464  
**\$289.99**

**Defender 6x6 & PRO**  
 715005412  
**\$319.99**



Cargo divider



Headache rack



**LINQ TIRE HOLDER**

- Cargo box spare-tire holder.
- Heavy-duty steel construction.
- Inside and outside anti-corrosion coating with durable powder coat finish.
- Mounts on top of the bed walls using the easy, tool-less LinQ System.
- Compatible with Bed Wall Extender.
- Uses BRP standard wheel bolt pattern to mount tire (nuts included).
- Accommodates BRP tires up to 28" (wheel not included).
- Quickly allows installation in multiple positions thanks to the LinQ System.

**Defender (except 6x6 & PRO models), Defender MAX**  
 715003448  
**\$224.99**





### LinQ FRONT RACK

- Rugged looking front rack mounts on top of vehicle hood and provides additional storage.
- Heavy-duty 1.25" (3.2 cm) diameter steel-tube construction.
- Inside and outside anti-corrosion coating with durable powder coat finish.
- Flip-up configuration provides easy access to service area.
- Allows the installation of LinQ accessories (especially for use with LinQ Low Profile Basket [715004282]).
- Kit includes LinQ Base.
- Multiple bungee cord and tie-down anchor points.
- Requires Rancher Bumper (715002834/715005410) or Front Bumper (715002418 or 715005754) for installation.
- A great place to store tools while working in the field.

**Defender, Defender MAX (2019 & prior)**

715004312

**\$489.99**

**Defender, Defender MAX (2020 & up)**

715006064

**\$489.99**



Allows the installation of LinQ Low Profile Basket, see [p. 36](#)

### EXPERT CHOICE

#### NEW LOADOUT RACK

**Available in Fall 2020**

- LinQ installed versatile Rack that create a second level of storage.
- Adjustable height that goes from mid cab height to roof line.
- Modular basket adapts to different cargo with folding front and rear panels.
- Multiple hooks holes to hang items both inside and outside the rack.
- Basket accommodates multiple LinQ positions
- Combine with cargo net to create a hanging storage net below the basket for additional space.
- 2 Racks can be installed on Defender Pro & Defender 6x6.

**Defender, Defender MAX**  
715005447  
**\$1,429.99**



Adjust the height depending on your cargo.



### LINQ CARGO RACK

- Strong, durable steel rack.
- Easy and tool-less installation thanks to the LinQ System.
- Allows the installation of LinQ accessories.
- 2 racks can be installed at the same time.
- Allows multi-level storage on cargo bed, accommodates 5 Gal (19L) bucket.
- Helps keep cargo securely in place.
- Multiple bungee cord and tie-down anchor points.
- Kit includes LinQ Base.
- Provides more usable space in the cargo box.
- Extends vehicle cargo options.

**Defender, Defender MAX**

715006140

**\$414.99**

### LINQ CARGO BASE KIT

- Unique mounting fastener usable on any LinQ System accessory.
- Included: 2 LinQ Cargo bases and hardware.

**Defender, Defender MAX**

860201806

**\$34.99**



### LINQ REPLACEMENT PART

- Unique mounting fastener usable on any LinQ System accessory.
- Tool-less installation and removal.
- Sold in pairs.

**Defender, Defender MAX**

715001707

**\$27.99**



### LINQ BASE INSTALLATION KIT

- Required to install LinQ Cargo Base Kit on the cargo bed.

**Defender 6x6, Defender PRO**

860201812

**\$12.99**



### HANGING STORAGE BOX KIT

- Versatile rack designed to hold a standard storage box.
- Fully adjustable, the rack can be tailored to hold the crates in multiple positions: Headache rack position, inside the box along the sidewall, and outside the box along the side wall.
- Includes Can-Am branded storage box.
- Exterior Cargo Reinforcement Panel is recommended when used outside of bed wall.

**Defender, Defender MAX**  
715005449 • Black  
**\$174.99**



### CAN-AM STORAGE BOX

- (Not illustrated)
- Conventional 13" x 13" plastic storage box with Can-Am branding.
- Perforated bottom allows water and debris to escape.

**Defender, Defender MAX**

708303237 • Black

**\$15.49**

### EXTERIOR CARGO REINFORCEMENT PANEL

- (Not illustrated)
- Plate that attaches to the bed side to further support and protect bed wall when in outward position.
- Recommended use of the Hanging storage box and/or gun and tool holder when installed outside of the bed wall (except Defender 6x6 & PRO).

**Defender, Defender MAX**

715006198

**\$61.99**



PROTECTION AND CAPABILITY READY FOR THE ROUGH STUFF.



**EXPERT CHOICE**

**DELUXE HEADACHE RACK**

- Protects cab components from cargo load.
- Increases box capacity when used in tandem with the Bed Wall Extender (715002421).
- Required to install the Bed Wall Extender (715002421).
- Compatible with gear rail.

**Defender, Defender MAX**  
715002423  
\$459.99



**HEADACHE RACK**

- Full rear roll cage coverage offers a heavy-duty steel protective line of defense between your head or cab's components and the load in your cargo bed.
- Compatible with gear rail.
- Rack's open design helps maintain a clear rear view.
- Not compatible with Bed Wall Extender.

**Defender, Defender MAX**  
715003873  
\$289.99



**EXPERT CHOICE**

**BED WALL EXTENDER**

- Increases box capacity.
- Quick and easy tool-less modularity.
- Easily removable rear door can be latched open.
- Variable full or half height settings.
- Foldable top panels come off in seconds.
- Requires Deluxe Headache Rack (715002423).

**Defender, Defender MAX (except Defender 6x6 & Defender PRO)**  
715002421  
\$919.99

**Defender 6x6 & PRO models**  
715005411  
\$1,674.99



TOP PANELS FOLD DOWN INSTANTLY



**RACKS & HOLDERS**

**LINQ ADAPTER**

- Allows the installation of the LinQ Tool Holder to the Bed Wall Extender or the Deluxe Headache Rack.
- Sold in pack of 4.

**Defender, Defender MAX**  
715003058  
\$32.99

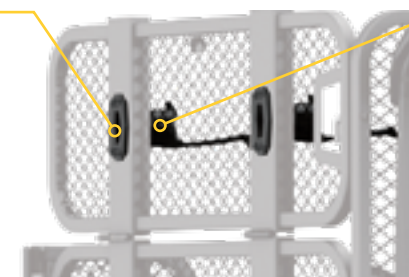

**LINQ TOOL HOLDER**

- Ultra-versatile tool holder.
- Convenient swivel-latch allows tools to be stored in any orientation.
- Suitable for installation onto the cargo walls, Deluxe Headache Rack, Adventure Roof Rack or Bed Wall Extender.
- If mounted on the Deluxe Headache Rack or the Bed Wall Extender, LinQ Adapter is required for installation.
- Sold in pairs.

**Defender, Defender MAX**  
715003059  
\$61.99



**TONNEAU COVER**

- Fitted to cover all of the items in your cargo box thoroughly.
- Prevents splash from entering the cargo box.
- Rolls up to the front.
- Easily removable for quick access.
- Not compatible with accessories that exceed the box height.

**Defender 2018 & up (except 6x6 & PRO, Mossy Oak Break-Up Country Camo model), Defender MAX**  
715006011 • Black  
\$294.99

**Defender, Defender MAX (2017 & prior)**  
715003048 • Mossy Oak Break-Up Country Camo  
\$389.99



**REMOVABLE STORAGE BIN**

- Handy, removable on-dash toolbox will make sure you have your critical equipment where you need it.
- Provides 1.7 Gal (6.3 L) of storage, and clips on and off in a snap.
- Water-resistant to ensure your contents remain safe and dry.
- Standard on all models except Base.

**Defender, Defender MAX**  
715004344  
\$87.99



**REMOVABLE STORAGE BIN - PASSENGER**

- Convenient passenger-side underseat storage polypropylene-injected 3.7 Gal (14 L) storage capacity bin.
- Bin installs and removes in a snap and comes with an integrated handle.
- Water-resistant.

**Defender, Defender MAX**  
715003314  
\$88.99



**DRIVER UNDERSEAT STORAGE BIN**

- Polypropylene-injected 4 Gal (15 L) capacity bin fits securely under the driver's seat.
- Front opening for quick and easy access.
- Ideal for storing weather-resistant items, such as ropes, tow straps and winch accessories that are needed at a moment's notice.

**Defender, Defender MAX**  
715003399  
\$129.99



**CENTER UNDERSEAT STORAGE BIN**

- Polypropylene-injected 2 Gal (8 L) capacity storage bin.
- Watertight design keeps ice and drinks cold.
- Easy to drain and wash by removing it with integrated handle.
- Accessible by lifting center seat section.

**Defender, Defender MAX**  
715003446  
\$104.99





**CARGO BED RAILS**

- Add integrated tie-down area to your cargo box while enhancing the look.
- Added cargo box protection.
- Inside and outside anti-corrosion coating with durable powder coat finish.
- Heavy-duty 1" (2.5 cm) diameter steel-tube construction.
- Add height to the bed side wall and serve as a tie-down anchor for ropes, straps or bungees.
- Not compatible with Bed Wall Extender.
- Sold in pairs.

**Defender (except 6x6 & PRO), Defender MAX**  
715003444  
\$129.99



**CARGO BED NET**

- Solid net designed to hook to the bottom of the cargo box for secure and compact confinement of your cargo.
- Keeps items tightly against the bed floor.

**Defender (except 6x6 & PRO), Defender MAX**  
715003445  
\$87.99



**LOWER DASHBOARD FOR HEATING SYSTEM**

- Replaces the dashboard that comes stock with the vehicle, and features a tablet that makes it possible for driver and passenger to conveniently store small items in the dash.
- To be installed when the Defrost, Heat & Ventilation System is installed.
- Use together with the Dash Storage Compartment Net for Heating System (715003544) to prevent the items placed in the dash storage compartment from falling.

**Defender, Defender MAX (2019 & prior)**  
715003441  
\$88.99



**DASH STORAGE COMPARTMENT NET FOR HEATING SYSTEM**

- Perfect for securing items in the dash storage area.
- To be installed when Lower Dashboard for Heating System is installed.

**Defender, Defender MAX (2019 & prior)**  
715003544  
\$33.99



**DASH STORAGE COMPARTMENT NETS**

- Perfect for securing items in the dash storage area.
- Not compatible with Defrost, Heat & Ventilation System.
- Sold in pairs.

**Defender, Defender MAX (except Limited models)**  
715003129  
\$33.99



**BED TOOL BOX**

- Large 40 Gal (150 L) multifunction weather-resistant tool box designed for cargo beds.
- Rotomolded construction provides exceptional rigidity and durability.
- Features cup holders and integrated groove for pipe or 2x4 cutting.
- Sized to give you the option of installing 2 tool boxes in the cargo bed (quick bolt-on installation).
- Double side openings with lockable covers and rubber latches.

**Defender, Defender MAX**  
715003028  
\$419.99



**SOFT STORAGE BAG**

- 11.8 Gal (45 L) capacity soft cargo bag designed with vehicle's rear in mind to maximize potential storage.
- 3 sections.
- Weatherproof.

**Defender, Defender MAX**  
715003759 • Black  
\$184.99



Vehicle shown is a Can-Am Outlander.

**BACKREST REAR STORAGE**

- Netting installs easily.
- Made from polyester that won't discolor.
- Sold in pairs.

**Defender MAX**  
715003019  
\$67.99



**STORAGE 2.6 GAL (10 L) BAG**

- Roll-top dry bag for fully protecting your cargo from the elements.

**Defender, Defender MAX**  
269502121  
\$38.99



# RACKS & HOLDERS



## EXPERT CHOICE

### NEW ACCESSORY BAR

- Strong accessory bar allowing installation or hanging items off the back.
- Holes for carabiners, duck decoy hangers or other items.
- LinQ anchors allow installation of many LinQ accessories.
- Pre-drilled holes for lights installation.

**Defender, Defender MAX**

715005450  
\$129.99



### ADVENTURE ROOF RACK

- Ideal cargo solution for packing everything you need to live your Off-Road experience fully and completely.
- Built with heavy-duty 1.25" (3.2 cm) diameter steel tubing.
- Modular LinQ support plates allow for installation of most LinQ cargo accessories.
- Integrated mounting points for lights can hold up to 8 pod-type LED lights (6 front and 2 back) or a 39" (99 cm) LED bar (front)—see table for compatibility.
- Features anchor points for spare tire attachment.
- Spare Tire Tie-Downs sold separately.
- Add the Cargo Box Net or the Cargo Box Elastic Net to secure and confine your cargo in the rack.
- Not compatible with Bimini Roof.

**Defender**

Loads of up to 40 lb (18 kg).

715003870  
\$634.99

**Defender MAX**

Loads of up to 75 lb (34 kg).

715004391  
\$779.99

### BUILD YOUR OWN ADVENTURE ROOF RACK!

Shown here with:  
SPARE TIRE WITH TIE-DOWNS  
LinQ CARGO BOX, LinQ TOOL HOLDER  
& 4" (10 CM) LED LIGHTS



### SPARE TIRE RATCHET TIE-DOWNS

- 3-way ratcheting tie-down strap with loop ends.
- Designed to securely hold spare tires on accessories equipped with integrated spare tire attachment points.
- Adjustable to accommodate most common UTV tire sizes.
- Ratchet and junction ring made of durable zinc-plated steel.
- Required for spare tire attachment on Adventure Roof Rack.

**Defender, Defender MAX**

28000606  
\$32.99



## EXPERT CHOICE

### LINQ TOOL & GUN HOLDER

- 2-in-1 holding rack can be used both on the job or on the hunt.
- Includes 5 locations to securely hold tools and guns using rubber grips and retention straps at the top and a rubber mat with gunstock shaped molding at the bottom.
- Easy to remove, install or reposition using our simple and secure LinQ System.
- Can be attached at multiple positions along the cargo bed walls, facing inside or outside the bed.
- Recommended to use with the Exterior Cargo Reinforcement Panel (715006198) when installed outside the bedwall.

**Defender,**

**Defender MAX**

715005466  
\$529.99



### GUN BOOT MOUNT BY KOLPIN

- Fits one Kolpin Gun Boot 6.0 Impact.
- Lightweight and extremely durable.
- Easily adjustable without the use of any tools.
- Offers precision gun angle adjustability.
- Requires Gear Rail for installation.

**Defender, Defender MAX**

715001420  
\$87.99



### ADDITIONAL GUN BOOT MOUNT

(Not illustrated)

**Defender,**

**Defender MAX**

715001586  
\$154.99

### GUN BOOT 6.0 IMPACT BY KOLPIN

- Extra room for pistol-grip-type weapons and small bipods.
- Easily fits firearms up to 51" (1.3 m) in total length.
- Provides ample room for 2.4" (60 mm) scopes.
- Hatchback design allows easy access.
- Snap-close cover with locking capability.
- Ergonomically designed handle and molded attachment points for sling.
- Designed to accommodate left- and right-hand bolt-action rifles and shotguns.
- Requires Gear Rail and Gun Boot Mount by Kolpin for installation.
- Includes removable, shock-absorbing foam and nylon Impact liner for superior interior protection.
- Compatible for dual mount with additional Gun Boot Mount.

**Defender, Defender MAX**

715001419  
\$87.99



### DUAL GUN HOLDER

- Accommodates shotguns, rifles or muzzleloaders.
- Mounts in the cab, on floor board between driver and passenger.
- Rubber pads provide gun protection.
- Can be removed to allow a center passenger.
- Anti-corrosion coating with durable powder coat finish.
- Comes with all hardware for easy installation.
- Keeps your weapons within easy reach and protected within the cab area.
- Refer to your local regulations governing the transportation of firearms before purchase.

**Defender, Defender MAX**

715005265  
\$214.99

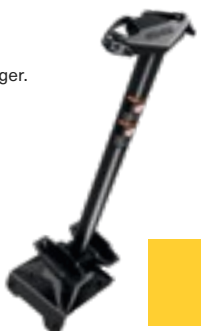



## 4-SEASON FIREARMS PROTECTION WITHIN REACH, WITH TOUGH & DURABLE GUN BOOTS FROM KOLPIN

### STRONGHOLD GUN BOOT IMPACT<sup>+</sup> BY KOLPIN<sup>+</sup>

- Compact low-profile design with Kolpin Stronghold styling securely holds up to 52" (132 cm) long rifles and shotguns with optics.
- Includes a removable, shock absorbing foam Impact<sup>+</sup> liner.
- Single-handed opening with an attached lid for quick access along with an integrated closure strap.
- For use with the Kolpin Stronghold Auto-Latch Mount System.

**Defender, Defender MAX**  
705011442  
\$122.99

### STRONGHOLD AUTO-LATCH MOUNT BY KOLPIN

- Auto-latching design provides quick and secure gun boot attachment to your vehicle.
- Bracket is made from rugged high-impact, reinforced nylon and coated steel.
- For use with Stronghold Gun Boot.
- Requires Gear Rail For Stronghold (715004089).

**Defender, Defender MAX (except X mr models)**  
715003899  
\$81.99

### GEAR RAIL FOR STRONGHOLD

- Designed for the Stronghold Auto-Latch Mount by Kolpin.
- Can hold up to two Stronghold Gun Boots (two Latch Mounts required).
- Deluxe Headache Rack (715002423) or Gear Rail Adapter (715003392) required.

**Defender, Defender MAX**  
715004089  
\$184.99

### GEAR RAIL

- Stationary rail system specially designed for your side-by-side vehicle.
- Universal mounting options for many Kolpin accessories like Gear Grips, Gun Boot 6.0, Gun Boot Mount and Universal Saw Press.
- Rail is made with heavy-duty 7-gauge extruded anodized black aluminum.
- Mounts on roll bar.
- Includes one versatile Gear Rail Mount by Kolpin.
- Requires Deluxe Headache Rack (715002423), Headache Rack (715003873) or Gear Rail Adapter (715003392).

**Defender, Defender MAX (except X mr models)**  
715003391  
\$329.99



### GEAR RAIL ADAPTER

- Allows the installation of gear rails directly onto the cargo box without the need for a headache rack.

**Defender, Defender MAX (except X mr models)**  
715003392  
\$184.99



### GEAR RAIL MOUNT BY KOLPIN

- Accessory bracket for mounting additional accessories to the Gear Rail.
- Includes C-clamp and metal mounting brackets.

**Defender, Defender MAX**  
715001422  
\$50.99



### DOUBLE GUN BAG

- Shell constructed with heavy-duty, weather-resistant polyester to shelter guns from dust and other outdoor elements, while the thick interior padding protects the guns from shocks.
- Fits perfectly on rear cage, and guns are readily accessible from both sides of vehicle.
- Design features include a removable center pocket that can be mounted on both sides of the bag, and extra front storage pockets for hunting gear.
- Solid, quick installation.
- Not compatible with rear wind protection, headache racks and gear rails.
- May interfere with the tilt function of the Defender 6x6 or Defender PRO models' bed.

**Defender (except XT Cab, X mr models),  
Defender MAX (except XT Cab and Limited package)**  
■ 715003133 • Black  
\$179.99  
■ 715003134 • Mossy Oak Break-Up Country  
\$214.99



STRENGTH FOR A PURPOSE: PERFECT-FIT HEAVY-DUTY GUN BAG KEEPS FIREARMS SECURE

### UNIVERSAL SAW PRESS BY KOLPIN

- Specially crafted for transporting your chainsaw securely and safely aboard your side-by-side vehicle.
- Heavy-duty, black powder-coated metal bracket designed to attach any chainsaw model with up to a 20" (51 cm) bar.
- Rubber pads provide cushion and tight fit.
- Hinged design for quick removal.
- Holds saw in vertical position or 45° angle in either direction.
- Requires Gear Rail.
- Protective sheath included.

**Defender, Defender MAX (except X mr models)**  
715001423  
\$134.99

### DURABLE MOUNT & HOLSTER KEEP YOUR CHAINSAW READY TO WORK



Vehicle shown is a Can-Am Commander.



### GEAR GRIPS BY KOLPIN

- Durable, flexible grips cushion and protect while providing a custom fit for a variety of items from 1" to 4" (2.5 cm to 10 cm) in diameter.
- Heavy-duty design for carrying bows, fishing poles, rakes, farm tools and more.
- Quick-release button opens grip quickly for easy access to gear.
- Heavy-duty base system built for the toughest adventures.
- Easy installation on tubular racks, extension racks, brackets or bumpers.
- Sold in pairs.

**Defender, Defender MAX**  
715001421  
\$87.99



### FUEL PACK BRACKET BY KOLPIN

- Easy, quick and secure bracket for your fuel pack that leaves plenty of room for your other gear.
- ¼-turn-action knob allows quick and easy removal of fuel pack from bracket.
- Not EC compliant to attach fuel packs.

**Defender, Defender MAX**  
715001427  
\$71.99





# LIGHTS



## 39" (99 CM) DOUBLE STACKED LED LIGHT BAR (270W)

- Equipped with 54 5W Cree LEDs.
- 24,300 lumens.
- Not compatible with Full Windshield, Flip Windshield and Can-Am Intrusion Bar.
- Lights up to more than 2900 ft (900 m) in front of the vehicle and around 115 ft (35 m) wide on each side.

See table for installation location and requirements.

**Adventure Roof Rack, Adventure Roof Rack MAX**

715004007  
\$904.99



## 15" (38 CM) DOUBLE STACKED LED LIGHT BAR (90 WATTS)

- Equipped with 18 5W Cree LEDs.
- 8,400 lumens.
- Rugged and waterproof.
- EC compliant.

See table for installation location and requirements.

**Defender, Defender MAX**

715002934  
\$474.99



## 10" (25 CM) DOUBLE STACKED LED LIGHT BAR (60 WATTS)

- Equipped with 12 5W Cree LEDs.
- 5,400 lumens.
- Rugged and waterproof.
- Packs a big punch for its size.
- EC compliant.

See table for installation location and requirements.

**Defender, Defender MAX**

715002933  
\$374.99



**BUILD YOUR LIGHTING SYSTEM.** Refer to page 50.

## 24,300 LUMENS

Lights up to more than 2900 ft (900 m) in front of the vehicle and around 115 ft (35 m) wide on each side.

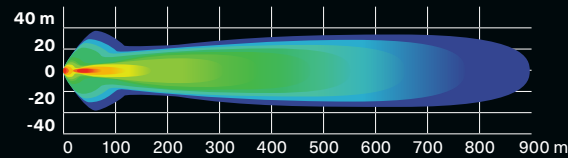

## 8,400 LUMENS

Lights up to more than 1900 ft (580 m) in front of the vehicle and around 65 ft (20 m) wide on each side.

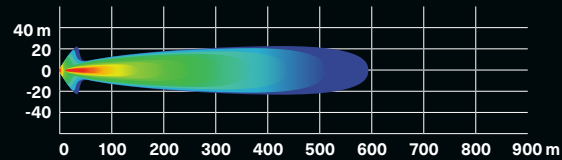

## 5,400 LUMENS

Lights up to more than 1500 ft (460 m) in front of the vehicle and around 65 ft (20 m) wide on each side.

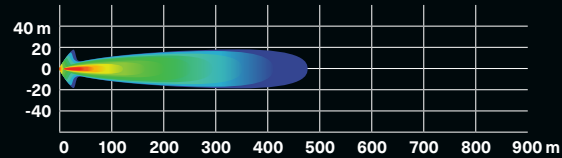

## 4" (10 CM) ROUND LED LIGHTS (2 X 25 WATTS)

- 25W LED spotlights.
- 1,800 lumens.
- Rugged and waterproof.
- Includes basic wiring and switch.
- Can-Am branded grill.
- Sold in pairs.
- Not EC compliant.

See table for installation location and requirements.

**Defender, Defender MAX**

715002935  
\$474.99



## 3.5" (9 CM) LED LIGHTS (2 X 14W)

- 14W LED lights producing 1,260 lumens each.
- Equipped with 6 high power LEDs in a heavy-duty die cast aluminum housing.
- Features 2 attachment points — if one attachment point fails due to a collision, rotate to the next channel point and re-mount the light.
- Sold in pairs.
- EC compliant.

See table for installation location and requirements.

**Defender, Defender MAX**

715003666  
\$254.99



## LED DRIVING LIGHTS

- Spot lens for a narrow and long light beam spread, ideal when driving at higher speeds.

715003666  
\$254.99

## LED FLOOD LIGHTS

- Flood lens for a wide light beam spread, ideal for working applications like plowing or for cornering, dusty or foggy riding conditions.

715003665  
\$254.99

## 1,800 LUMENS

Perfect fit with the Light Rack and most bumpers.

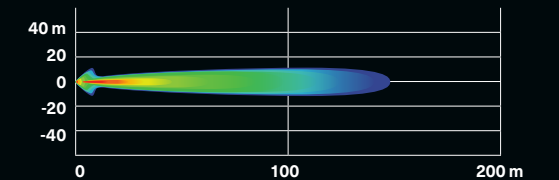

## 1,260 LUMENS

LED Driving Lights

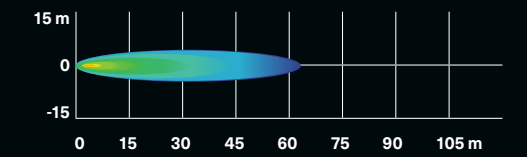

## LED Flood Lights

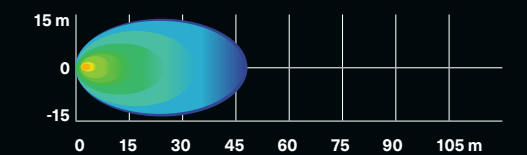



## BUILD YOUR LIGHTING SYSTEM IN 4 EASY STEPS

		2 CHOOSE YOUR LIGHTS				
		10" (25 Cm) Double Stacked LED Bar	15" (38 cm) Double Stacked LED Bar	39" (99 cm) Double Stacked LED Bar	4" (10 cm) Round LED LIGHTS (Sold in pairs)	3.5" (9 cm) LED Lights (Sold in pairs)
FIND YOUR PLATFORM	DEFENDER, DEFENDER MAX 2019 & PRIOR	715002933 PLUS 715002454 (Light Power Cable)	715002934 PLUS 715002454 (Light Power Cable)	N/A	715002935 (4" Round), 715003665 (3.5" Flood) or 715003666 (3.5" Spot) PLUS 715002454 (Light Power Cable)	
	DEFENDER, DEFENDER MAX 2020 & UP	715002933 PLUS 715006034 (Light Power Cable)	715002934 PLUS 715006034 (Light Power Cable)	N/A	715002935 (4" Round), 715003665 (3.5" Flood) or 715003666 (3.5" Spot) PLUS 715006034 (Light Power Cable)	
FIND YOUR PLATFORM	DEFENDER, DEFENDER MAX 2019 & PRIOR	715002933 PLUS 715002454 (Light Power Cable)	N/A	N/A	N/A	
	DEFENDER, DEFENDER MAX 2020 & UP	715002933 PLUS 715006034 (Light Power Cable)	N/A	N/A	N/A	
FIND YOUR PLATFORM	DEFENDER & DEFENDER MAX (EXCEPT XT CAB)	715002933 PLUS 715003094 (Roof Power Cable) & 715003098 (Front Roof Liner)	715002934 PLUS 715003094 (Roof Power Cable) & 715003098 (Front Roof Liner)	N/A	715002935 (4" Round), 715003665 (3.5" Flood) or 715003666 (3.5" Spot) PLUS 715003094 (Roof Power Cable) & 715003098 (Front Roof Liner)	
	DEFENDER, DEFENDER MAX XT CAB LIMITED	715002933	715002934	N/A	715002935 (4" Round), 715003665 (3.5" Flood) or 715003666 (3.5" Spot)	
FIND YOUR PLATFORM	DEFENDER & DEFENDER MAX (EXCEPT XT CAB LIMITED)	N/A	Front only: 715002934 PLUS 715003417 (Power Cable) & 715003094 (Roof Power Cable) & 715003098 (Front Roof Liner)	Front only: 715004007 PLUS 715005822 (Power Cable) & 715003094 (Roof Power Cable) & 715003098 (Front Roof Liner)	Front or Rear: 715002935 (4" Round), 715003665 (3.5" Flood) or 715003666 (3.5" Spot) PLUS 715003417 (Power Cable) & 715003094 (Roof Power Cable) & 715003098 (Front Roof Liner)	
	DEFENDER, DEFENDER MAX XT CAB LIMITED	N/A	Front only: 715002934 PLUS 715003417 (Power Cable)	Front only: 715004007 PLUS 715005822 (Power Cable)	Front or Rear: 715002935 (4" Round), 715003665 (3.5" Flood) or 715003666 (3.5" Spot) PLUS 715003417 (Power Cable)	

### 4 ORDER

#### ORDER ALL PART NUMBERS IN INTERSECTING BOX

\*NOTE: When installing more than one light kit, additional Light Power Cable or Mounting Kit is required.



PERFECT MOUNT SOLUTION FOR THE LIGHTS OF YOUR CHOICE.



4" (10 CM) ROUND LED LIGHTS



15" (38 CM) DOUBLE STACKED LED LIGHT BAR

#### LIGHT RACK

- Rugged steel construction serves as both mount and protection for accessory light systems.
- Lights not included.
- Front Roof Liner is required for installation on the roof (except Cab models or with Deluxe Sport Roof [715002511]).
- Power Cable (715003094), Sport Roof (715002430), Bimini Roof with Sun Visor (715002849), Deluxe Sport Roof (715002511) or Sport Roof for MAX (715003038) required for installation.
- Integrates elegantly and seamlessly into our roof products.

**Defender, Defender MAX**  
715002456  
\$194.99



#### REAR CARGO LIGHT

- Powerful 55W H3 illumination for rear cargo area.
- Convenient in-dash switch.
- Wiring included.
- Sport Roof (715002430), Deluxe Sport Roof (715002511) or Sport Roof for MAX (715003038) is required for installation.
- Not EC compliant.
- Not compatible with headache rack on Defender 6x6 and Defender PRO.

**Defender, Defender MAX (2020 & up)**  
715007077  
\$179.99



#### RAM+ LED SPOTLIGHT

- 540 lumens LED light (9 Watt) heavy-duty spotlight standard-equipped with 1" (2.5 cm) diameter rubber-coated double ball and socket system.

**Defender, Defender MAX (2019 & prior)**  
710005423  
\$149.99



#### DOME LIGHT

- LED array integrates perfectly with vehicle.
- Wiring included.
- Can be installed on cage or roof, with or without roof liner.

**Defender, Defender MAX**  
715002455  
\$87.99



#### LED SIGNATURE LIGHTS

- The stylish LED set puts the finishing touch to your Defender, accentuating its aggressive stance.
- Included on Limited and Lonestar models.

**Defender, Defender MAX (2020 & up)**  
715006896  
\$254.99



#### ROOF POWER CABLE

- (Not illustrated)
- Brings power from the battery.
- Required for installation of some electrical accessories.

**Defender, Defender MAX**  
715003094  
\$56.99

#### LIGHT KIT POWER CABLE

- (Not illustrated)
- Power cable for installation of compatible Can-Am light kits at front bumper location.

**Defender, Defender MAX (2019 & prior)**  
715002454  
\$51.99

**Defender, Defender MAX (2020 & up)**  
715006034  
\$50.99

# AUDIO & COMMUNICATION SYSTEMS

STAY ENTERTAINED ON JOBSITES AND LONG RIDES WITH COMPLETE BLUETOOTH MUSIC INTEGRATION.



BRING YOUR FAVORITE MUSIC WHEREVER YOU ROAM.



## RUGGED. WATERPROOF. POWERFUL.

Add up to 4 ultra-sturdy outdoor speakers, designed to be Can-Am tough. Our Overhead Audio System will rock with high-fidelity sound... everywhere.

## STAY CONNECTED

Our Rugged Radios Car-to-Car System is perfect for communicating with friends and family on group rides.

### EXPERT CHOICE

#### OVERHEAD AUDIO SYSTEM

- Rugged waterproof Jensen® Bluetooth Stereo Audio System offers multi-source input: AM/FM/WB and USB (iPod® and iPhone® ready).
- Convenient white LED-backlit LCD display and buttons.
- Stream from any Bluetooth-enabled device (smartphone, MP3 player).
- Powerful 4x40W amplifier with remote turn-on.
- Voice-control of AVRCP-active device.
- 30 programmable AM/FM stations with auto-store/pre-set scan.
- Separate RCA audio output and input.
- UV-resistant finish / corrosion-resistant components.
- Requires Sport Roof (715002430), Front Roof Liner (715003098) or Deluxe Sport Roof (715002511) and Power Cable (715003094).



#### COMPLETE OVERHEAD AUDIO SYSTEM

- Complete with 4 ultra-sturdy outdoor speakers (2 front and 2 rear) and 4 black speaker boxes.

**Defender, Defender MAX**  
715002019  
\$1,089.99

#### OVERHEAD FRONT AUDIO SYSTEM

- Complete with 2 ultra-sturdy front outdoor speakers and black speaker box.

**Defender, Defender MAX**  
715003095  
\$889.99

#### RUGGED RADIOS CAR-TO-CAR SYSTEM

- Perfect for communicating with friends and family on group rides.
- Push-to-talk button conveniently mounted on the steering wheel.
- Includes radio mounting bracket, helmet speaker, mic kit and base charger.
- May be synched with the Rugged Radios Intercom System (715002891).
- 2-4 mile range.

- This kit includes:**
- RH-5R Rugged Radios 5-Watt Dual Band Handheld Radio
  - Helmet Speaker/Mic Kit
  - Push-to-talk buttons
  - Mounting bracket
  - Base station charger

**Defender, Defender MAX**  
715003440  
\$444.99



#### RUGGED RADIOS INTERCOM SYSTEM

- Specifically designed to facilitate clear in-vehicle communication between driver and passenger(s).
- Expandable to 4 people.
- Includes music port for enjoying your favorite tunes.
- Seamless integration with in-dash switch panel.
- May be synched with the Rugged Radios Car-To-Car System (715003440).

**Defender, Defender MAX**  
715002891  
\$779.99



**EXPERT CHOICE**

**REAR VIEW MIRROR & CAMERA MONITOR**

- Fully waterproof rearview camera and monitor kit.
- Multiple camera feeds can be seen with the rearview camera, to see what you need.
- Unit replaces stock rearview mirror (screen is integrated in the unit's replacement rearview mirror).
- Camera uses infrared light for night vision capabilities.

**Defender, Defender MAX**  
715004905 Black  
\$539.99



**BACK-UP MONITOR AND CAMERA KIT**

- Fully waterproof rearview camera and monitor kit.
- The camera is one of the clearest and sharpest available on the market, with 250,000 pixel image resolution and a 2.1 mm lens with 130° viewing angle.
- Features 18 infrared lights that allow up to 50 ft. (15.24 m) visibility in complete darkness, an auto iris sensor that adapts to light intensity changes and an adjustable sunshade.
- 7" (17.78 cm) digital TFT LCD color monitor comes with power harness and can support up to two camera inputs.
- The camera can be roof mounted to monitor your cargo load or to see farther behind, and it can be mounted under the cargo box for hitching purpose.
- Not compatible with Defrost Heat and Ventilation System or HVAC.

**Defender, Defender MAX**  
715003834  
\$684.99



**EXPERT CHOICE**

**BATTERY CHARGER/MAINTAINER**

- Keeps stored lead-acid batteries charged.
- Charges and maintains small batteries.
- Microprocessor controlled multi-stage charging for added precision, safety and battery life.
- Reverse hook-up protection helps protect battery and charger from damage.
- Automatically detects 6- or 12-volt batteries.
- Press the display button to show the charge progress.
- Content: 3 amp battery charger, clamp adapter, DC adapter, 24" (61 cm) fused ring leads harness with weather cap, owner's manual.

**715005061**  
\$71.99



**DIGITALLY ENCODED SECURITY SYSTEM (D.E.S.S.™) KEYS**

- Top-security anti-theft protection for your vehicle.
- Encrypted chip technology restricts access to your vehicle's electronic ignition system.
- One vehicle / One code.
- A vibration / shock-resistant ball-and-socket design that ensures a reliable connection.

Comes with 3 programmable keys:  
• Work key: Limits vehicle speed to 40 kph (25 mph) but does not limit engine torque.  
• Normal key: Limits vehicle speed to 70 kph (44 mph) and 10% torque reduction.  
• Performance key: No restrictions.

**Defender, Defender MAX**  
715002458  
\$259.99



**JUMP STARTER**

- IPX3 water-resistant and enclosed output ports.
- 4 LED battery indicators for easy read on battery charge level.
- Compact design, will conveniently fit in your backpack, glove box or any other storage compartment.
- 2.4A + 1A/5V USB ports for fast charging of all USB devices.
- Smart cable provides protection against reverse polarity, short circuit, low voltage, high temperature and reverse charging.
- Built-in LED light (3 modes).
- Content: 300CA jump starter, SA858 smart cable clamp, MC-USB to USB charging cable, travel bag, user manual.

**715005062**  
\$149.99



**QUICK CONNECT BATTERY CABLE**

- Quickly and easily connect and charge different items with your charger.
- Included in the Battery Charger/Maintainer.
- Sold individually.

**715005408**  
\$10.49



**QUICK CONNECT CABLE WITH BATTERY INDICATOR**

- Quickly and easily connect and charge different batteries with your charger.
- 3-color LED indicator provides constant battery health indication.
- Sold individually.

**715006055**  
\$25.99

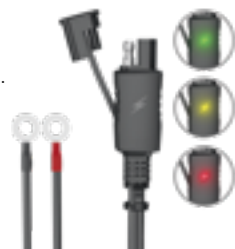

**3-MODE SWITCH**

- Switches quickly and conveniently between normal/work/eco modes.
- Work mode: Reduced throttle sensitivity for smoother acceleration and reduced load impact.
- Eco mode: Increased fuel economy.
- In-dash plug-and-play mount.
- Standard on 2020 models.

**Defender, Defender MAX**  
715004445  
\$39.99



**EXPERT CHOICE**

**AUXILIARY BATTERY INSTALLATION KIT**

- Allows you to add a second 30Ah battery for that dual battery setup that will give you the extra juice you'll need to power auxiliary electrical components like a sound system or winch.
- Additional battery sold separately (515176151).
- Equipped with an integrated smart battery isolator that will prevent your auxiliary electrical components from draining your starting battery.
- Kit includes an additional battery junction block, all necessary wiring and the battery holder.

**Defender, Defender MAX (2019 & prior)**  
715003758  
\$329.99

**Defender, Defender MAX (2020 & up)**  
715006035  
\$389.99



**REAR 12V POWER OUTLET**

- Kit brings power source to the cargo box area.
- Installs into the rear cab firewall.
- Easy plug-in harness included.

**Defender, Defender MAX (2019 and prior)**  
715003846  
\$61.99



**USB POWER OUTLET KIT**

- Recharges your electronic devices while riding\* (smartphone, MP3, heating gear, etc.).
  - Dual port USB connectors.
- \*The power outlet is not capable of recharging all device types while riding.

**Defender, Defender MAX (2020 & up)**  
219400510  
\$37.99



**GARMIN MONTANA® 680T GPS**

- Rugged and waterproof, the Montana 680T is element-proof.
- 4" dual-orientation, sunlight-readable touchscreen and glove-friendly touchscreen display to give you vivid colors and high-resolution images.
- 8-megapixel autofocus camera automatically geotags photos.
- Tracks both GPS and GLONASS satellites for improved positioning and typically faster fixes.
- Preloaded TOPO maps, plus 1-year BirdsEye Satellite Imagery subscription.
- 3-axis compass with barometric altimeter.
- Specific GPS cradle included (vehicle mounting kit required).
- Includes a preloaded map for US.

**Defender, Defender MAX**  
715002830  
\$789.99

**European Version**  
• EC compliant.  
• Includes preloaded European recreation map.  
**715003456**



**RAM GPS MOUNT**

- Allows for GPS integration onto vehicle.
- Standard AMPS hole pattern for Garmin Cradle.

**Defender, Defender MAX**  
715003325  
\$77.99



**CANADIAN MAP FOR GARMIN MONTANA 680T GPS**

- (Not illustrated)
- Additional and readily-programmable Canadian basemap for Garmin Montana 680T GPS system.
- Requires Garmin Montana 680T GPS (715002830).

**Defender, Defender MAX**  
710005065  
\$194.99

### DEFROST, HEAT & VENTILATION SYSTEM

- Best integrated system on the market with 3-ventilation speed and in-dash adjustable temperature.
- Adjustable/directional vents.
- 10 vents specially positioned for better windshield and side windows defrosting/deicing, foot and hand heat.
- Easy-service air filter.
- Once installed, you might want to add storage space with the Lower Dashboard for Heating System and Dash Storage Compartment Net for Heating System.

**Defender, Defender MAX 2019 & prior (not compatible with HD5 Motorization)**  
715004917

**\$1,629.99**

- Best integrated in-dash system on the market with 3 fan speeds and adjustable temperature.
- Adjustable/directional vents can be closed to concentrate heat at specific areas.
- A total of 8 vents specially positioned for windshield and occupant heating.
- Easy-to-service air filter.
- Includes the replacement lower dashboard compartment for the heating system.
- Dash Storage Compartment Net for Heating System is recommended.

**Defender, Defender MAX (except Defender PRO models) 2020 & up (not compatible with HD5 motorisation)**

715005904

**\$1,799.99**



### EXPERT CHOICE

#### HEATED STEERING WHEEL

- Ruggedly constructed steering wheel designed to withstand cold conditions while channeling heat directly to your hands.
- Perfect for making hand mobility and grip readily available, e.g., hunting, manual farming.
- Replaces stock steering wheel.
- This kit includes the heated steering and in-dash switch.
- Draws a maximum of 45W and 3.2A at 13.5V.
- Heated Accessories Wiring Harness (710005757) is required on all models except XT Cab 2020 & up, which requires Heated Accessories Wiring Harness (710006036).

**Defender, Defender MAX**

715003837

**\$494.99**



#### HEATED GRAB BAR COVER

- Made tough to hold up to the stresses of rough riding, this heated cover will keep your passenger's hands warm and securely gripped during long cold outings.
- Easy to install and remove.
- This kit includes the heated grab bar cover and in-dash switch.
- Heated Accessories Wiring Harness (710005757) is required on all models except XT Cab 2020 & up, which requires Heated Accessories Wiring Harness (710006036).

**Defender, Defender MAX**

715003835

**\$259.99**



#### HEATED SEAT

- 25W seat heater delivers chill-free riding comfort.
- Hi/Low temperature settings allow you to control the desired degree of warmth.
- This kit includes one carbon fiber seat heater, foam sheet and in-dash switch.
- Installs directly in the original seat cushion.
- Heated Accessories Wiring Harness (710005757) is required for installation on front seat.
- Heated Accessories Wiring Harness (715006036) is required for installation on Defender XT Cab and Limited models.
- Heated Accessories Wiring Harness (715006004) is required for installation on rear seats on MAX models.

**Defender, Defender MAX**

715006112

**\$159.99**



#### HEATED SEAT HARNESS FOR MAX MODEL

- (Not illustrated)
- Electric harness required to hook up and operate rear heated seats.

**Defender MAX**

715006004

**\$199.99**

#### HEATED ACCESSORIES WIRING HARNESS

- (Not illustrated)
- Electric harness required to hook up and operate heated accessories.
- Power up to 4 accessories: 2 hand accessories (grab bar/steering wheel) and 2 seat covers.

**Defender, Defender MAX (2020 XT CAB & Limited models)**  
715006036

**\$209.99**

**Defender, Defender MAX (except 2020 XT CAB & Limited models)**  
710005757

**\$129.99**

# WINCHES & HITCHES

## WARN<sup>†</sup> VRX

- Extreme IP68-rated waterproof sealing keeps the elements out.
- Durable all-metal construction.
- Black powder-coated finish and stainless steel fasteners for corrosion resistance.
- Robust clutch design based on 70+ years of WARN 4WD hub lock know-how.
- Load-holding brake for great control.
- Smooth and reliable all-metal three-stage planetary gear train.
- Dash-mounted rocker control and corded remote.
- Limited lifetime warranty (mechanical), 3-year warranty (electrical).
- Pulling strength capability of 4,500 lb (2,041 kg).
- Winch electrical harness (715006032) is required for installation.

#### WARN VRX 45 WINCH

- 50 ft. of ¼" (15 m of 6.3 mm) wire steel cable.
- Roller fairlead.

**Defender, Defender MAX**

715006110

**\$669.99**



#### WARN VRX 45-S WINCH

- 50 ft. of ¼" (15 m of 6.3 mm) synthetic rope.
- Cast aluminum fairlead.

**Defender, Defender MAX**

715006111

**\$804.99**



## CAN-AM HD

- Ergonomic clutch handle.
- Rugged all-steel gears and bushings for more torque and durability.
- Automatic 100% load-holding brake.
- Sealed solenoid for all-weather protection.
- Weather sealed corded remote and dash mounted switch.
- EC compliant.

#### CAN-AM HD 4500 WINCH

- Pulling strength capability of 4,500 lb (2,041 kg).
- 43 ft. of 15/64" (13.1 m of 6.3 mm) wire steel cable.
- Heavy-duty 4-way roller fairlead.
- Winch Electrical Harness (715007078) is required for installation on Base and DPS models.

**Defender, Defender MAX**

715006416

**\$389.99**



#### CAN-AM HD 4500-S WINCH

- Pulling strength capability of 4,500 lb (2,041 kg).
- 50 ft. of ¼" (15.2 m of 6.35 mm) synthetic rope.
- Corrosion-proof aluminum hawse fairlead.
- Winch Electrical Harness (715007078) is required for installation on Base and DPS models.

**Defender, Defender MAX**

715006417

**\$534.99**





**PULL HEAVY LOADS AND LARGE GAME INTO THE BED WITH EASE.**

**NEW CARGO BED WINCH**

- Allows you to pull heavy loads into the cargo box easily.
- Perfect for hunting applications, i.e., loading game.
- Includes support base made of heavy-duty 2" (5 cm) steel tubing, winch and weather-sealed corded remote.
- 750 lb (340 kg) maximum pulling capacity.
- Electronic security module to prevent vehicle damage that could occur if loaded vehicle exceeds manufacturer's gross weight rating.
- Adapter Kit (715004709) required for installation with Gear Rail Adapter.
- Requires Powertilt bed for Defender 6x6 and PRO.

**Defender, Defender MAX**  
715006355  
**\$749.99**

**SYNTHETIC WINCH CABLE\***

- 50' of ¼" (15.2 m of 6.35 mm) synthetic cable for Warn winch.
- Warn Hawse Fairlead is required when upgrading to a synthetic cable to avoid damage and premature wear of the cable.

**With Warn winch**  
705015070  
**\$184.99**

- 50' of ¼" (15.2 m of 6.35 mm) synthetic cable for Can-Am HD winches.
- Hawse Fairlead (715006426) required when upgrading to a synthetic cable to avoid premature cable damage and wear.

**With Can-Am HD winch**  
715006430  
**\$159.99**



**SYNTHETIC CABLE EXTENSION**

- Lightweight ¼" (6.35 mm) diameter, easy to handle and won't rattle in cargo box.
- Easily attaches to winch cable to provide additional 50' (15.2 m) of distance.
- 4,500 lb (2,041 kg) single line capacity.

715001120  
**\$179.99**



**REPLACEMENT WIRE ROPE\***

- 55' of ¼" (16.8 m of 6.35 mm) wire rope for Warn winch kit.
- 4,500 lb (2,041 kg) pulling strength.

**With Warn winch**  
715006699  
• 43' of ¼" (13.1 m of 6.3 mm) wire rope.  
• 4,500 lb (2,041 kg) pulling strength.  
**\$92.99**

**With Can-Am HD winch**  
705014978  
**\$25.99**



**WARN HAWSE FAIRLEAD\***

- Double-powder-coated construction.
- Required to use the Synthetic Winch Cable (705015070) on Warn winches.
- To be used with synthetic winch cables only.

**With Warn winch**  
705208797  
**\$124.99**



**CAN-AM HD HAWSE FAIRLEAD**

- A must when upgrading your winch with a synthetic cable, this corrosion-proof aluminum hawse fairlead will prevent the cable from snapping in a corner of a roller fairlead and from wearing prematurely due to the rough surface of the worn roller guide.
- Must be used with synthetic cables only.

**With Can-Am HD winch**  
715006426  
**\$61.99**



**ROLLER FAIRLEAD**

- Suggested when changing the wire rope.
- Heavy-duty replacement fairlead for winches.

**With Can-Am HD winch**  
710007082  
**\$58.99**



**WIRED REMOTE CONTROL**

- This kit allows winch owners to add the hand-held remote to vehicles with a stock winch.
- Works in conjunction with the mini-rocker switch.
- Remote control (710007050) and connection socket are included with Can-Am HD winch.
- EC compliant.

**With Can-Am HD winch**      **With Warn winch**  
715006504                      710001002  
**\$27.99**                              **\$76.99**



**WIRELESS REMOTE CONTROL**

- The system is quick and easy to install, thanks to a wiring harness with an integrated antenna and all necessary mounting hardware.
- Allows you to operate your winch from anywhere within a 50' (15.2 m) radius, increasing your recovery options.
- All components are weatherproof.

**With Warn winch (Defender 2019 & prior)**  
715002542  
**\$239.99**



**DROP TOW BAR**

- Sturdy 2" (5 cm) ball-less tow bar.
- Conveniently set at standard trailering height.
- Requires Higher Front Receiver Hitch (715003109).

**Defender, Defender MAX**  
715002521  
**\$129.99**



**WINCH ELECTRICAL HARNESS**

- (Not illustrated)
- Required to install a winch on a Defender without a factory-installed winch.

**Defender, Defender MAX (2019 & prior)**  
715003093  
**\$67.99**

**Defender, Defender MAX (2020 & up)**  
715007078  
**\$134.99**

**MULTIMOUNT WINCH HARNESS**

- (Not illustrated)
- Converts Removable Winch Mounting Kit into a practical multimount winch kit.

**Defender**  
710004869  
**\$66.99**

**Defender MAX, Defender 6x6**  
710005082  
**\$104.99**

**REMOVABLE WINCH MOUNTING KIT**

- Allows you to remove your winch when needed.
- Use in combination with the Multimount Winch Harness to quickly and conveniently relocate a front-mounted winch to the rear of the vehicle.
- Not compatible for use with the Lower Front Receiver Hitch.
- Requires Higher Front Receiver Hitch (715003109).

**Defender, Defender MAX (except Limited models)**  
715001652  
**\$394.99**



**LOWER FRONT RECEIVER HITCH**

- Heavy-duty 1,500 lb (680 kg) towing capacity 2" (5 cm) receiver hitch.
- Expand and enhance functionality by pairing it with Higher Front Receiver Hitch and Removable Winch Mounting Kit (need to relocate winch from its standard mounting position).

**Defender, Defender MAX**  
715002519  
**\$129.99**



**HIGHER FRONT RECEIVER HITCH**

- Heavy-duty 1,500 lb (680 kg) towing capacity 2" (5 cm) receiver hitch.
- No need to relocate winch from its standard mounting position.

**Defender, Defender MAX (except Limited models)**  
715003109  
**\$129.99**



**FRONT & REAR HITCH DRAWBAR**

- Standard on 2" (5 cm) receiver hitch.
- It offers 1,500 lb (680 kg) of towing capacity.
- Hitch ball not included.

**Defender, Defender MAX**  
715000972  
**\$91.99**

**European Version**  
• Drawbar with 2" (50 mm) hitch ball.  
715001473  
705206264 (T Homologated)



**RUBBER RECEIVER PLUG**

- Rubber cap for 2" (5 cm) Receiver Hitch.

705204503  
**\$14.99**



\*Ask your dealer or visit canamoffroad.com for price details.

# SEATS

## CENTRAL HEADREST

- Headrest for front-center-seating position on 3-seated models and for rear-center-seating position on MAX models.
- Front Headrests are available separately for front passengers on MAX models.
- Headrests are required for all passengers on some regulated trails.
- Not EC compliant.

**Defender, Defender MAX**  
715005163  
\$164.99

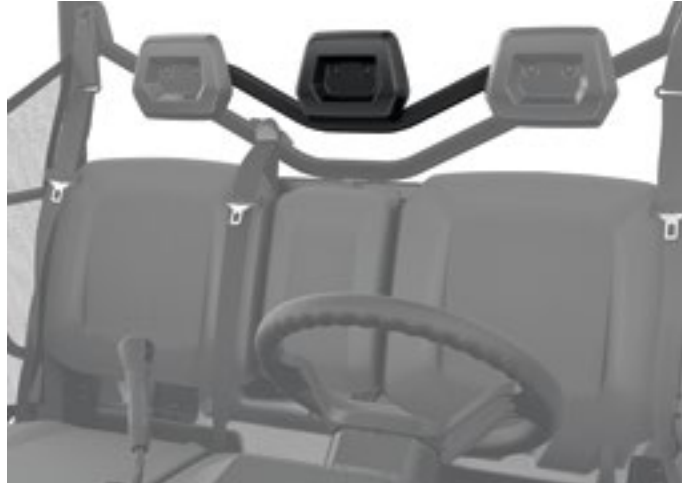

## FRONT HEADRESTS

- Additional headrest for all three front-seating positions on MAX models.
- Central Headrest is available separately for rear-center-seating positions on MAX models.
- Headrests are required for all passengers on some regulated trails.
- Not EC compliant.

**Defender MAX**  
715005164  
\$259.99

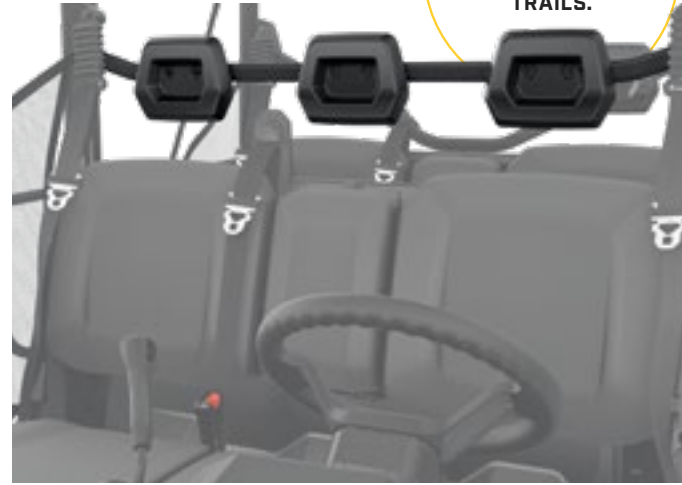

**HEADRESTS ARE REQUIRED FOR ALL PASSENGERS ON SOME REGULATED TRAILS.**

## X MR / XT-P BOLSTER SEATS

- Bolster seat upgrade gives occupants additional support and comfort for recreational riding.
- Features added side padding and redesigned profile to help you control and enjoy your side-by-side vehicle to the fullest.
- Reinforced seat skin.
- Compatible with rear seat on MAX models.
- Not compatible with Heated Seat Covers.
- Standard on Defender X mr and XT-P models.

**Defender, Defender MAX**  
■ 715004363 • Black / Can-Am Red  
■ 715004678 • Black / Brown  
\$1,049.99



## ADJUSTABLE DRIVER'S SEAT

- Driver seat upgrade that delivers an added 3 in. (8 cm) of forward/rearward adjustability for increased comfort and facilitated ingress/egress.
- Standard feature on XT, XT Cab and Mossy Oak Hunting Edition models.

**Defender, Defender MAX**  
715005519  
\$389.99



Increase comfort with 3 extra inches (8 cm) of to and fro adjustment

# PERFORMANCE



S3 FRONT HIGH CLEARANCE A-ARM

MASTER ROUGH TERRAIN—INCREASE THE SPACE BETWEEN LOWER A-ARMS FOR MORE CLEARANCE OVER LARGE OBSTACLES.

## S3 FRONT HIGH CLEARANCE A-ARM

- Prevents A-Arm damage over rough terrain.
- Preserves factory ride quality and turning radius without reducing performance.
- Not compatible with Apache 360 LT Track System and Front A-Arm Protectors.
- "S3 for Can-Am" branded.

Contact your authorized dealer or visit our online store at [can-amoffroad.com](http://can-amoffroad.com)

■ 715003784 • Black  
\$504.99

■ 715005116 • Sunburst Yellow  
\$489.99



## S3 REAR HIGH CLEARANCE A-ARM

- Prevents A-Arm damage over rough terrain.
- Preserves factory ride quality and turning radius without reducing performance.
- Not compatible with Apache 360 LT Track System and Rear A-Arm Protectors.
- "S3 for Can-Am" branded.

Contact your authorized dealer or visit our online store at [can-amoffroad.com](http://can-amoffroad.com)

■ 715003785 • Black  
\$504.99

■ 715005118 • Sunburst Yellow  
\$489.99



## NEW BRAKE HOLDING MECHANISM

- Maintains constant pressure on the brake pedal to keep the vehicle from moving on sloped terrain, without having to put the transmission in P (park).

**Defender, Defender MAX**  
715004733  
\$189.99



# GRIP LIKE NEVER BEFORE



Can-Am exclusive:  
Respond to Off-Road conditions like never before with 4WD powered by Smart-Lok™ Technology.

Smart-Lok™ is the most advanced Off-Road differential at your command. It's a fully lockable on-the-fly front differential with electronically controlled automatic modes that always returns maximum traction in every condition, period.

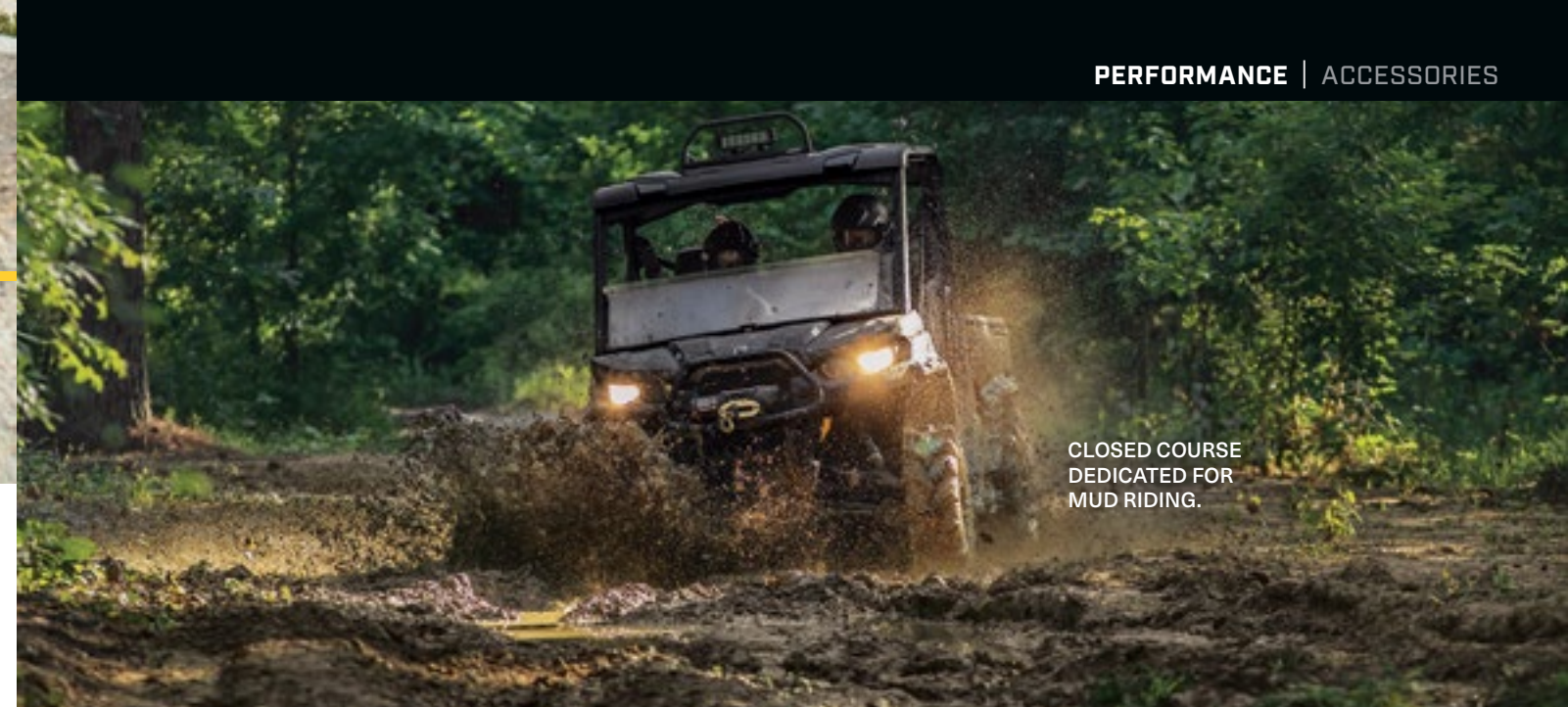

CLOSED COURSE DEDICATED FOR MUD RIDING.

## 1 START WITH THE SMART-LOK™ DIFFERENTIAL

### SMART-LOK™ DIFFERENTIAL

- Can-Am-exclusive Smart-Lok™ technology constitutes a true full lockable on-the-fly front differential with electronically controlled automatic modes.
- Choose your differential settings according to your riding need: "2x4" for rear wheel traction only, "4x4 Front Diff Lock" for a fully locked 4 wheel drive, and "4x4 Smart Modes" that offer preset, intelligent calibrations for your type of riding.
- Using multiple input sources, "Smart Modes" will instantaneously engage locking with the right load at the right moment to procure maximum traction while retaining low-speed maneuverability, allowing for optimal placement and a feeling of confidence.
- The Smart-Lok™ Kit comes standard with the Trail Mode.
- Requires Performance Half Shafts (2x) and Front Differential Kit for installation.

**Defender, Defender MAX (2019 & prior)**  
705402371  
\$1,527.99



## 2 GET THE SMART-LOK™ INSTALLATION KIT & PERFORMANCE HALF SHAFT

### SMART-LOK™ INSTALLATION KIT

- (Not illustrated)
- Includes all necessary hardware and wiring for Smart-Lok™ Differential installation.

**Defender, Defender Max (2018 & prior)**  
715005331  
\$339.99

**Defender, Defender Max 2019**  
715005332  
\$339.99



### PERFORMANCE HALF SHAFT

- High-performance design ideal for Off-Road use, with superior wheel power and acceleration for racing, dunes and desert riding.
- Includes CVs, Shaft and Boots with the best suited geometry for your Can-Am vehicle.

**Defender and Defender Max (2019 & prior - except X mr, XT-P and XT CAB 2018 & up)**  
705402353  
\$199.99

**Defender, Defender MAX XT Cab 2018-2019, Lone Star Edition 2019 & prior**  
705402458  
\$199.99



## 3 FINE-TUNE YOUR RIDING ENVIRONMENT WITH A SMART MODE MODULE (OPTIONAL)

These modules allow you to add the **Mud, Rock or Trail Activ** Smart Mode to vehicles equipped with the Smart-Lok™ Differential Kit.  
• Only one Smart Mode Module can be installed at a time.



- Designed to deliver superior traction in the deepest mud holes.
- When high engine torque and/or slippage is detected, Smart-Lok™ will fully lock the front end.
- The system will stay locked until throttle release.

### MUD SMART MODE MODULE

**Models with Smart-Lok™ Differential**  
715005282  
\$154.99



- Designed to help cross challenging rocks.
- When high engine torque is detected at low vehicle speed, Smart-Lok™ will progressively lock the front end and will stay engaged until throttle release to prevent wheel slippage and provide optimal traction.
- The progressive engagement allows for easier steering when maneuvering the vehicle.

### ROCK SMART MODE MODULE

**Models with Smart-Lok™ Differential**  
715005283  
\$154.99



- Designed for aggressive riding delivering the ultimate cornering precision.
- When high engine torque and/or an increase in vehicle speed is detected, Smart-Lok™ will progressively engage the front end and maintain it engaged until throttle release or vehicle speed reduction.
- The progressive engagement allows for lower smooth steering effort.

### TRAIL ACTIV SMART MODE MODULE

**Models with Smart-Lok™ Differential**  
715005284  
\$154.99

### SNORKEL KIT

- Raises point of engine and CVT air intakes so vehicle can be semi-submersed in water/mud without taking in water to the engine.
- Not compatible with Headache Racks, Gear Rail equipment, DragonFire Cargo Bed Roll Bar and Windshield Wiper & Washer Kit.
- Snorkel Extension Kit is available for roof level air intake and CVT exhaust.
- Adapter for Snorkel Kit (715004414) and Sealed Air Box (707800714) are required for installation on 2017 and prior models.
- Standard on Defender X mr models.

**Defender, Defender MAX (except Defender PRO)**  
715003727  
\$779.99



### ADAPTER FOR SNORKEL KIT

- (Not illustrated)
- Required for the installation of Snorkel Kit (715003727) on Defender 2017 and prior models.
  - Includes rear firewall for Snorkel Kit and hardware.
  - Standard on Defender 2018 and up models.

**Defender and Defender MAX 2017 & prior**  
715004414  
\$109.99

### SNORKEL EXTENSIONS

- Extend the Snorkel Kit for roof engine and CVT air intake.
- Add aggressive look to your vehicle and help keep your intakes clear from mud, snow, dust, etc. in severe riding conditions.
- Not compatible with all rear panels and windows, Rear Cargo Light and roof-mounted Rear View Camera.
- Snorkel Kit (715003727) is required, except for X mr models.

**Defender, Defender MAX**  
715004415  
\$259.99



### SEALED AIR BOX

- (Not illustrated)
- Required when installing the Snorkel Kit (715003727) on Defender and Defender MAX 2017 and prior models.
  - Standard on Defender 2018 and up models.

**Defender, Defender MAX 2017 & prior**  
707800714  
\$189.99





**BELIEVE IT: YOUR DEFENDER IS A FEW MODS AWAY FROM BEING A TRUE MUD-READY MONSTER.**

**AIR INTAKE PRE-FILTER**

- Adds extra protection to your engine in harsh riding conditions.
- Helps keep air filter cleaner.
- Filter blocks particles larger than 0.007" (0.19 mm).
- Easy, tool-less installation.
- Necessary to maintain vehicle warranty when tracks are installed.
- Required to install the Apache and Backcountry Track Systems.



**Defender (except X mr models), Defender MAX**  
715003483  
\$46.99

**EMERGENCY KIT**

- Complete emergency kit provides all essential equipment and supplies to get out of most unfavorable situations powersport enthusiasts can find themselves in.
- Includes: Jumper Cables, Air Compressor, Tire Repair Kit, First Aid Kit, Ratchet Tie-Down, Duct Tape, Tow Strap 3,300 lb (1,500 kg), Zip-Ties, Cloth Rags.

**Defender, Defender MAX**  
715004359  
\$174.99

**SNORKEL PRE-FILTER**

- Pre-filter specifically for snorkels.
- Adds extra protection to your engine in harsh riding conditions.
- Helps keep air filter cleaner.
- Filter blocks particles larger than 0.005" (0.13 mm).
- Necessary to maintain vehicle warranty when tracks are installed.

**Defender, Defender MAX (except Defender PRO)**  
715005597  
\$104.99



**HEAVY-DUTY SPRING KIT**

- This set of heavy-duty springs will stiffen your suspension.
- Perfect for reducing vehicle overall sag when shocks are under heavy demand: heavy loading and hauling or for snow clearing.
- Complete kit of 4 springs.
- Not compatible with Defender HD5, XT CAB, Mossy Oak Edition & X mr models and Defender Max.

**Defender (2019 & prior), Defender HD8 (2020 & up)**  
715005084  
\$334.99



**FRONT HEAVY-DUTY SPRINGS**

- This set of heavy-duty springs will stiffen your suspension.
- Perfect for reducing vehicle sag on heavy jobs like snow clearing or heavy load hauling.
- Sold in pairs.

<b>Defender (2018 &amp; prior, Base, DPS &amp; XT models only)</b>	<b>Defender MAX (2018 &amp; prior, Base, DPS &amp; XT models only)</b>
715002450	715004280
\$184.99	\$209.99

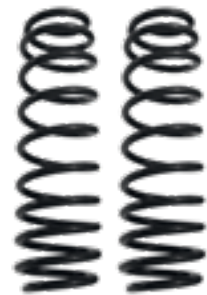

**FOAM AIR FILTER BY TWIN AIR<sup>†</sup>**

- The best choice for the harshest conditions.
- Multiple staged oiled filtering foam for superior dust retaining capacity with high air flow.
- Washable and reusable.

**Defender, Defender MAX**  
715003630  
\$129.99



# APACHE TRACK SYSTEMS



EACH TRACK HAS A SPECIFIC PURPOSE AND IS DESIGNED WITHOUT COMPROMISE FOR WORK AND PLAY. WHETHER IT'S FOR DEEP SNOW RIDING, TRAIL RIDING OR FOR HEAVY LOADS, APACHE TRACKS ARE AKIN TO FLOATING ACROSS THE TERRAIN.

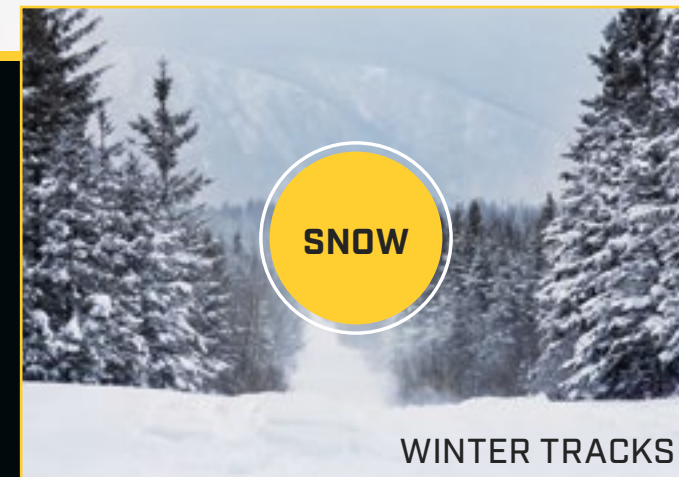

WINTER TRACKS

**APACHE BACKCOUNTRY**  
Finally explore winter with no traction limitations and no compromise, thanks to the unmatched performance of Apache Backcountry track kits. Engineered to thrive in the deepest snow—for work or play. Don't let winter stand in the way.



YEAR-ROUND TRACKS

**APACHE 360, 360 LT**  
These track kits improve your vehicle's ground clearance and increase its contact patch with the terrain. Adapt your track setup to the conditions you'll be riding in and the purpose of your ride, with the Apache 360 and 360 LT systems: as our all-season, all-terrain masterpieces.

# WINTER TRACKS

GET THE MOST OUT OF YOUR CAN-AM VEHICLE THIS WINTER FOR ALL YOUR ENDEAVORS.

Explore without compromise. Ride on untouched trails, traveling deep into winter's embrace and you'll know: The same technology behind our world-renowned snowmobiles is at your command. With a larger contact patch, and more aggressive track design, travel beyond what you thought possible with the best snow performance.

COVERED BY A  
**1-YEAR WARRANTY**

# YEAR-ROUND TRACKS

WORK & PLAY YEAR ROUND THROUGH MUD, SNOW, & ALL TYPES OF TERRAIN.

Rise above terrain, weather, and whole seasons with the Apache 360 LT track kit—the upgrade that takes the Can-Am experience to another level. Designed for superior traction and carrying heavier loads in soft terrain, the 360 LT track kit can be installed on ATV and SSV vehicles and used year round for exploring and completing tough tasks.

COVERED BY A  
**2-YEAR WARRANTY**

## APACHE BACKCOUNTRY

Efficient frame and rail design ensures weight is evenly distributed

Added ground clearance of 6.4" (16.2 cm)

Aggressive track design with a 2" (5 cm) lug height for maximum traction

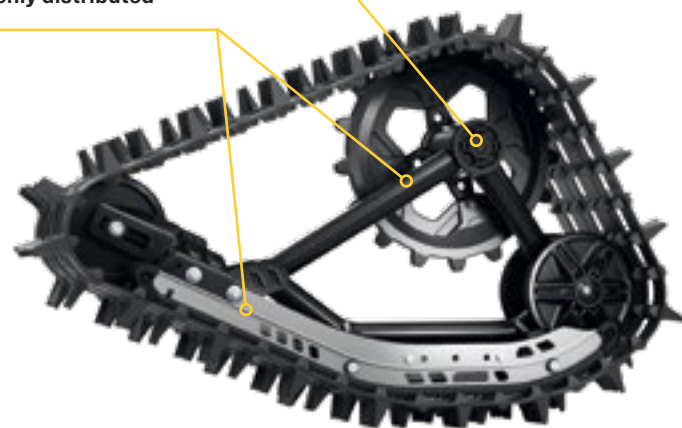

Largest contact patch anywhere: 37% more than the Apache 360 LT

### APACHE BACKCOUNTRY LT TRACK KIT

- Tracks designed to deliver the best snow performance on the market with unmatched flotation level and traction on snow surface.
- Large contact patch, 37% bigger than the Apache 360 LT.
- Impressive added ground clearance of 6.4" (16 cm) helps keep the vehicle over the snow.
- Lightweight snowmobile-inspired rail design.
- Aggressive track design with 2" (5 cm) lug height for maximum traction on snow.
- Apache Backcountry LT Mounting Kit, Track DPS Module and Engine & CVT Pre-Filter are required.
- Fine-tune your track system using extra Idler Wheels, Sliders with Vespel Inserts and Rail Ice Scratcher.
- For winter use only.

**Defender, Defender MAX (except 6x6)**  
715005891  
**\$7,599.99**

### APACHE BACKCOUNTRY LT MOUNT KIT

- (Not illustrated)
- Required for installation of the Apache Backcountry LT Track System.
  - DPS module and Pre-Filter are required and sold separately.

See table p. 68 for fit, compatibility and requirements.

715005888	715005493	715006196
<b>\$739.99</b>	<b>\$649.99</b>	<b>\$799.99</b>

## APACHE 360 LT

Added ground clearance of 4.5" (11.4 cm)

Quick & easy installation

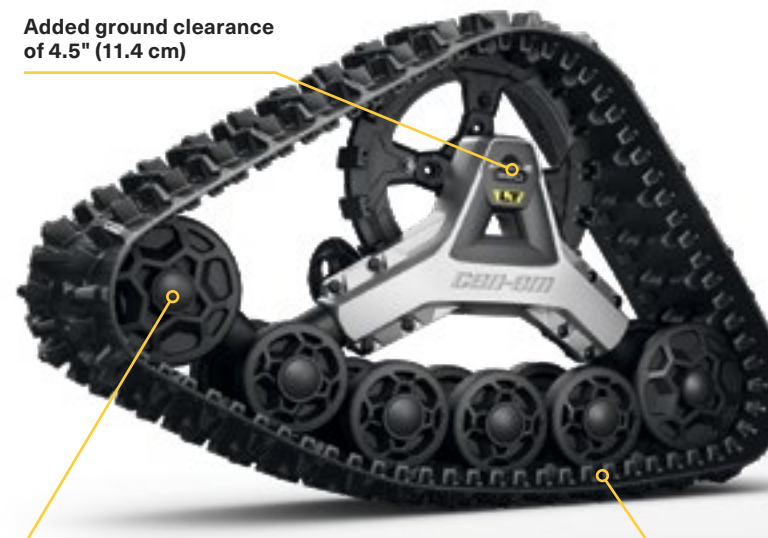

Unique adjustable contact patch system to tackle the toughest year-round conditions



Rubber over molded heavy-duty double bearing wheels and offset wheel spacing reduce friction and vibration while ensuring reliability

Total ground surface area of 2,473.7 in<sup>2</sup> (14,784 cm<sup>2</sup>)

### APACHE 360 LT TRACK SYSTEM

- Multifunctional tracks designed to support heavy loads and to fit on most Can-Am Off-Road vehicles.
- Extra contact patch adjustment for better performance over rough terrain.
- Contact patch is 7 to 9% bigger than the Apache 360's.
- Average ground clearance increase of 4.5" (11.44 cm).
- 1" (2.5 cm) lugs in the front and 1.25" (3.2 cm) in the back.
- Apache 360 LT Mounting Kit is required.

**Defender, Defender MAX (except 6x6)**  
715005103  
**\$4,999.99**

### APACHE 360 LT MOUNTING KIT

- (Not illustrated)
- Required to install Apache 360 LT Track System (715003064).
  - Track DPS Module and Air Intake Pre-Filter not included.

See table p. 68 for fit, compatibility and requirements.

715004831	715005492
<b>\$514.99</b>	<b>\$679.99</b>

715004832  
**\$539.99**

### RAIL ICE SCRATCHERS

Provide additional lubrication in hard and icy conditions and extends slider life. Rail mounted, small, light. Design expands on coil concept to allow reversing without damage. Easily stored when not in use.

**Apache Backcountry Track System**  
860201728  
**\$109.99**



### NEW EXTRA WHEEL KIT

- Additional wheel kit for Backcountry LT rear tracks.
- Reduces drag and rolling resistance in hard snow conditions or when transporting heavier loads.
- Extends slider life in hard snow conditions.
- Includes two wheels, cross shaft and mounting hardware per kit to service one track corner.
- Up to two kits per rear track can be installed.

**Apache Backcountry LT Wheel kit**  
715006293  
**\$124.99**



### TRACK DPS MODULE

- (Not illustrated)
- An innovative DPS module that ensures speedometer accuracy and optimized steering assist, which make for perfect track control and riding ease.
  - Required to install the Apache and Backcountry Track Systems.

715004707  
**\$159.99**

### AIR INTAKE PRE-FILTER

- Adds extra protection to your engine in harsh riding conditions.
- Helps keep air filter cleaner.
- Filter blocks particles larger than 0.007" (0.19 mm).
- Easy, tool-less installation.
- Necessary to maintain vehicle warranty when tracks are installed.
- Required to install the Apache and Backcountry Track Systems.
- Not compatible with Snorkel kit.

**Defender, Defender MAX**  
715003483  
**\$46.99**



### SNORKEL PRE-FILTERS

- Pre-filter specifically for snorkels.
- Adds extra protection to your engine in harsh riding conditions.
- Helps keep air filter cleaner.
- Filter blocks particles larger than 0.005" (0.13 mm).
- Necessary to maintain vehicle warranty when tracks are installed.

**Defender, Defender MAX**  
715005597  
**\$104.99**



### CVT AIR INTAKE RELOCATION KIT

- Relocates the CVT air intake protected in the cab area.
- Keeps the CVT air intake away from snow splashing from wheels or tracks.
- Highly recommended for track-equipped vehicles.

**Defender (except X mr and PRO models), Defender MAX**  
715004183  
**\$54.99**





QUICK REFERENCE FITTING GUIDE							
Track System	Model Year	Model	Track	Track Mount	DPS	Pre-filter without snorkel	Pre-filter with Snorkel
APACHE BACKCOUNTRY LT	2019 & Prior	Defender Base, DPS, XT, XT Cab 2017 & Hunting Edition, XT-P	715005891	715005888	715004707	715003483 715004183 (except X mr)	715005597 (and X mr)
	2019 & Prior	Defender XT Cab 2018-2019, Lonestar Edition & X mr		715006196			
	2020 & +	Defender Base, DPS (HD5 & HD8), XT(HD8)		715005888			
	2020 & +	Defender DPS (HD10), XT(HD10), XT-P, PRO DPS, PRO XT		715005493			
	2020 & +	Defender XT cab, XT Cab Limited, Hunting Edition, Lonestar Edition, X mr, PRO Limited, PRO LONESTAR		715006196			
APACHE 360 LT	2019 & Prior	Defender Base, DPS, XT, XT Cab 2017 & Hunting Edition	715005103	715004831	715004707	715003483 715004183 (except X mr)	715005597 (and X mr)
	2019 & Prior	Defender XT Cab 2018-2019, Lonestar Edition & X mr		715004832			
	2020 & +	Defender Base, DPS (HD5 & HD8), XT(HD8)		715004831			
	2020 & +	Defender DPS (HD10), XT(HD10), XT-P, PRO DPS, PRO XT		715005492			
	2020 & +	Defender XT cab, XT Cab Limited, Hunting Edition, Lonestar Edition, X mr, PRO Limited, PRO LONESTAR		715004832			

Vehicle width and length will be affected by tracks installation.

**NEW APACHE BACKCOUNTRY LT WHEEL KIT**

- Additional wheel kit for Backcountry LT rear tracks.
- Reduces drag and rolling resistance in hard snow conditions or when transporting heavier loads.
- Extends slider life in hard snow conditions.
- Includes two wheels, cross shaft and mounting hardware per kit to service one track corner.
- Up to two kits per rear track can be installed.

Apache Backcountry LT Track System  
(715005891 and 715004734)

715006293  
\$124.99



**REAR TIRE CHAINS**

- Improve your traction in mud and snow.
- Sold in pairs.

27" x 9"x 14"  
715003839  
\$119.99

29" x 9"x 14"  
715000225  
\$91.99



PROMOUNT PLOWS



THE PROMOUNT LINEUP WAS CREATED FOR BOTH PROFESSIONAL OPERATORS AND ENTHUSIASTS LOOKING TO TAKE THEIR TOOL KIT TO THE NEXT LEVEL. DESIGNED TO WORK AS EFFICIENTLY AS POSSIBLE, CAN-AM REIMAGINED THE PLOW FROM MOUNT TO BLADE.

MOST EFFICIENT MOUNTING SYSTEM

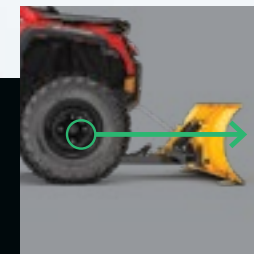

Underbelly mounting plate provides the optimal angle of attack for best push strength.

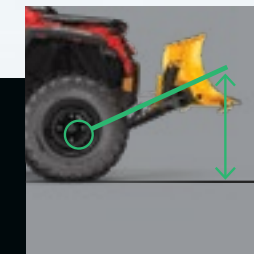

The forward mounted push frame provides industry leading lift height.



Low profile mounting plate has little impact on ground clearance and can be left installed year round.

CONNECTS WITH A CLICK

Attachable in **FOUR EASY STEPS**, the Can-Am ProMount plow system is the fastest, easiest way to start plowing and get the job done—minimal effort for maximum result.

1

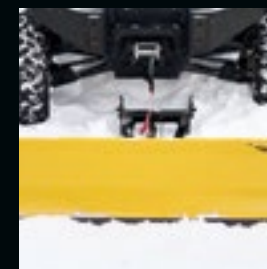

Drive straight toward the plow.

2

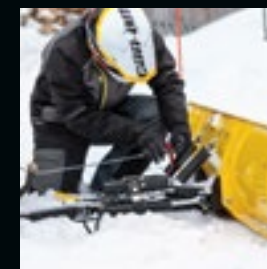

Attach the winch cable to the plow using a guiding hook/roller.

3



Lift the plow until it clips onto the mounting plate.

4

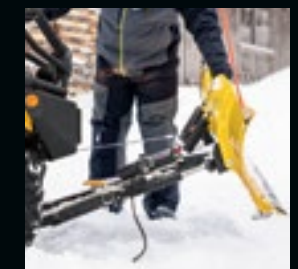

Remove the winch cable from the guide. You're ready to plow.

## CAN-AM PROMOUNT FLEX2 PLOWS

HMWPE (High Molecular Weight Polyethylene) technology gives Flex2 greater reliability, resistance to impact, and immunity to rust or deformation. Tough on jobs but flexible in the face of obstacles, the Flex2 blade simplifies work.

### CAN-AM PROMOUNT FLEX2 PLOW KIT

- These kits include:**
- Can-Am ProMount Flex2 Blade
  - Push Frame with Quick-Attach System
  - Mounting Plate

#### 72" BLADE

Defender, Defender MAX

■ 715006301 Black

\$1,369.97



### CAN-AM PROMOUNT FLEX2 BLADE

- Blades available individually to create your own kit.
- Compatible with Can-Am ProMount Blade accessories to further enhance plow versatility.

#### 72" BLADE\*

- Clears 66" (168 cm) when plow is fully angled.
- Blade height of 17" (43 cm).

ProMount Push Frame

■ 715004485 • Black

\$609.99



72" (183 cm)

**CONSULT YOUR DEALER FOR THE BEST PLOW WIDTH.** Made from 12-gauge steel and designed for efficient plowing, the ProMount steel blades are offered in multiple sizes to fit jobs large or small.

### CREATE YOUR OWN KIT

by choosing any plow type/length that you'd like for your push frame. **ProMount Push Frames are compatible with all the blades.**

## CAN-AM PROMOUNT STEEL PLOWS

Made from 12-gauge steel and designed for efficient plowing, the ProMount steel blades are offered in multiple sizes.

### CAN-AM PROMOUNT STEEL PLOW KITS

- These kits include:**
- Can-Am ProMount Steel Blade
  - Push Frame with Quick-Attach System
  - Mounting Plate

#### 72" BLADE

Defender, Defender MAX

■ 715006302 Black

■ 715006303 Yellow

\$1,239.97



72" (183 cm)

### CAN-AM PROMOUNT STEEL BLADES

- Blades available individually to create your own kit.
- Compatible with Can-Am ProMount Blade accessories to further enhance plow versatility.
- Not compatible with S3 Front High Clearance a A-Arm (715003784 & 715005116).



#### 72" BLADE\*

- Clears 66" (168 cm) when plow is fully angled.
- Blade height of 17" (43 cm).

ProMount Push Frame

■ 715004474 Black

■ 715006021 Yellow

\$479.99

#### 66" BLADE\*

- Clears 60" (152 cm) when plow is fully angled.
- Blade height of 17" (43 cm).

ProMount Push Frame

■ 715006337 Black

■ 715006338 Yellow

\$399.99

**CONSULT YOUR DEALER FOR THE BEST PLOW WIDTH.** Made from 12-gauge steel and designed for efficient plowing, the ProMount steel blades are offered in multiple sizes to fit jobs large or small.

### CREATE YOUR OWN KIT

by choosing any plow type/length that you'd like for your push frame. **ProMount Push Frames are compatible with all the blades.**

## CAN-AM PROMOUNT ANGLE PLOWS

### NEW CAN-AM ANGLE BLADES

- Make the job easier with the right tools, clear long alleys and make the task easier by sending the snow further out of the way.
- Wing end of plow measures 25" (63 cm) high and tapers down to 16" (41 cm).
- One-way "winged" state plow designed to throw snow higher.
- Rubber flap designed to keep snow away from the driver.
- Can-Am branded.

#### 72" (183 CM) STEEL ONEWAY STATE BLADE

■ 715007264 · Black  
\$549.99

#### 66" (168 CM) STEEL ONEWAY STATE BLADE

■ 715007263 · Black  
\$499.99



## YOUR JOB, YOUR CHOICE

Get a custom solution that truly fits the task at hand—with quality components and no cut corners. The ProMount mounting plate, push frame, and blades are a universal system that can be adapted to your specific Can-Am and jobsite.

### CAN-AM PROMOUNT PUSH FRAME WITH QUICK-ATTACH SYSTEM

- Heavy-duty steel tubes designed to withstand the roughest use.
- Mid-mount carriage provides ultimate push strength and traction.
- Designed for maximum plow lift height.
- Features a self-aligning quick-attach system, an easy foot release pedal and an ergonomic handle for plow angle adjustment.
- Plow Roller Fairlead and Plow Limit Switch recommended to extend winch cable lifespan.
- Can-Am ProMount Mounting Plate required for installation.
- Blade swivels left or right, 5 positions.
- Large pin designed for easy blade rotation to eliminate dirt and snow buildup at pivot point.

**Defender, Defender MAX**  
715003910  
\$599.99



### CAN-AM PROMOUNT MOUNTING PLATE

- Required to install the Can-Am ProMount Push Frame with Quick-Attach System.
- Mounting plate precision-designed to stay on year round without compromising ground clearance.
- Not compatible with S3 Front High Clearance A-Arm (715003784 and 715005116).

**Defender, Defender MAX**  
715004484  
\$159.99



### CONSULT YOUR DEALER FOR THE BEST PLOW WIDTH.

Made from 12-gauge steel and designed for efficient plowing, the ProMount steel blades are offered in multiple sizes to fit jobs large or small.

### PUSH FRAME EXTENSION

- 12" (30 cm) push frame extension required when plow is installed with Apache Track Systems.

**Defender, Defender MAX**  
715006257  
\$179.99

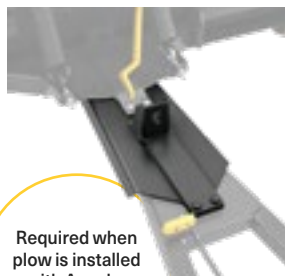

### CREATE YOUR OWN KIT

by choosing any plow type/length that you'd like for your push frame. **ProMount Push Frames are compatible with all the blades.**

## CAN-AM PROMOUNT PLOW ACCESSORIES



### 1 CAN-AM PROMOUNT EDGE MARKERS

- Help locate the edges of your plow.
- Height: 24" (60 cm).
- Sold in pairs.
- Compatible with Can-Am ProMount Steel and Flex2 Blades with or without Blade Extensions (except for the Can-Am ProMount Steel 54" (137 cm) Blades).

**ProMount System**  
715004206  
\$49.99

### 3 CAN-AM PROMOUNT DRIFT CUTTERS\*

- Help keep snow in the plow.
- Dimensions: 17" x 13" (43.2 cm x 33 cm).
- Sold in pairs.
- Compatible with Can-Am ProMount Steel and Flex2 Blades with or without Blade Extensions (except for the Can-Am ProMount Steel 54" (137 cm) Blades).

**ProMount System**  
715006258  
\$159.99

### 2 CAN-AM PROMOUNT PLASTIC WEAR BLADE\*

- To help prevent scratches on smooth driveways and markable surfaces.

**ProMount System**

66" (168 cm)	72" (183 cm)
715004482	715004483
\$99.99	\$159.99

### 4 CAN-AM PROMOUNT BLADE EXTENSIONS

- Add 3" (8 cm) each side.
- Compatible with Can-Am ProMount Blades (except for Can-Am ProMount Steel 54" [137 cm] Blade).
- Longer Wear Blade can be installed to further extend the extra length already provided by the extensions.
- Compatible with Can-Am ProMount Steel and Flex2 Blades (except for the Can-Am ProMount Steel 54" [137 cm] Blades).

**ProMount System**

■ 715004205 · Black
■ 715005319 · Yellow

\$124.99

### PLOW ANGLING SYSTEM\*

- Converts your plow system into an easy-to-control unit from the driver's seat.
- Allows you to have full up/down and left/right plow control at your fingertips by using the supplied joystick.
- Using one hand to control all plow motions will allow you to easily concentrate and manage your plowing tasks.
- Push Frame Extension (715006257) is required for installation with the Front Rancher Bumper.
- Not compatible with Apache Backcountry Track System.

**Any ProMount Push Frames and Blades**  
715006022  
\$1,189.99



### PLOW ROLLER FAIRLEAD

- Larger diameter lower roller reduces wear on wire rope for plow application.
- Can be used with all ProMount plows.

**Defender, Defender MAX**  
705203753  
\$89.99



### PROMOUNT PLOW LIMIT SWITCH

- (Not illustrated)
- For controlling the cable tension when over raising your plow system.
  - Prevents winch, plow push frame and vehicle damage.
  - Sensor relocated for optimal lift height.

**Defender, Defender MAX**  
715006259  
\$134.99

## SUPER-DUTY PLOW SYSTEM

The Super-Duty plow system and attachments are built to maximize your Defender's capabilities. Built to be extremely robust, efficient at tackling heavy jobs, and resistant to regular use—we call it "super" for a reason.

### SUPER-DUTY PLOW KITS

- A comprehensive plow system with manual lift and angling.
- Ultra-durable 72" (183 cm) blade made of 12-gauge steel with integrated reinforcement and heavy-duty push tubes to tackle the most demanding jobs.
- Requires a winch for raising and lowering.
- Convenient disconnect system for quick and easy installation or removal.
- Front mount provides minimum 11" (28 cm) lift distance.

**This kit includes:**

- 72" (183 cm) Super-Duty Plow
- Super-Duty Plow Push Frame
- Super-Duty Plow Mounting Kit

#### 72" (183 CM)

**Defender, Defender MAX**  
715003416  
**\$1,639.97**



**Shown with the following accessories:**

- Plow Rubber Flap (715001219)
- Plow Drift Cutter (715001218)
- Plow Edge Markers (715001216)

### SUPER-DUTY PLOW HYDRAULIC ANGLING KIT

- Allows you to have full up/down and left/right plow control at your fingertips.
- Pre-assembled, it comes with everything you need to turn your Super-Duty Plow into a quick, easy-to-control unit from the driver's seat.
- Using one hand to control all plow motions with the supplied joystick will allow you to easily concentrate and manage your plowing tasks.
- With this commercial grade kit, you will send snow exactly where you want reliably all winter long.
- Winch and plow sold separately.

**Defender, Defender MAX (2019 & prior)**

715002840  
**\$1,629.99**

**Defender, Defender Max (2020 & up)**

715006038  
**\$1,629.99**



Cylinders hydraulic



Electric hydraulic unit

### SUPER-DUTY PLOW PUSH FRAME EXTENSION

(Not illustrated)

- Extension to use the Super-Duty Plow with the Apache 360 LT Track System.
- Comes with Plow Magnetic Switch and Plow Pulley.
- Requires Front Bumper or Front Accessory Bar for installation.

**Super-Duty Plow**  
715001221 Black  
**\$364.99**

### PLOW BLADE EXTENSIONS

- Side extensions for widening your plow blade by 6" (15 cm) on each side.
- Include rubber flaps for extension parts.
- Sold in pairs.

**Super-Duty Plow**  
715001217  
**\$339.99**



### PLOW EDGE MARKERS

(Not illustrated)

- For a more accurate view of the width of your plow.
- Allows you to work closely around objects.

**Super-Duty Plow**  
715001216  
**\$44.99**

### PLOW DRIFT CUTTER

(Not illustrated)

- Keeps snow securely in the plow.
- Allows you to cut a cleaner pass.
- Sold individually.

**Super-Duty Plow**  
715001218  
**\$119.99**

### PLOW RUBBER FLAP

(Not illustrated)

- Keeps snow away from the driver and helps snow to roll in front of the plow.

**Super-Duty Plow**  
715001219  
**\$119.99**

### PLOW PULLEY

(Not illustrated)

- For use with the Super-Duty Plow.
- Helps winching efficiency.
- Requires Front XT Bumper.

**Super-Duty Plow**  
715002042  
**\$64.99**

### PLOW MAGNETIC SWITCH

(Not illustrated)

- Magnetic switch that stops the winch to prevent cable, winch and frame damage.
- For use with Super-Duty Plow.

**Super-Duty Plow**  
715001995  
**\$129.99**

# COVERS & ADD-ONS

### TRAILERING COVER

- Heavy-duty canvas made of UV-resistant solution-dyed polyester.
- Inner soft liner protects windshield and colored panels from abrasion.
- All high-abrasion areas are reinforced with a double canvas layer.
- Weather-resistant trailering cover protects your vehicle during storage and transportation.
- Opening for fuel cap.
- Quick and easy installation.
- Designed to perfectly fit your vehicle with or without Can-Am accessories.

**Defender, Defender 6x6**

715004453  
**\$329.99**

**Defender MAX, Defender PRO**

715004454  
**\$529.99**



### BOLT-ON<sup>+</sup> RETRACTABLE RATCHETING TIE-DOWNS

- Perfect for transporting your powersport vehicle or securing loads.
- Mounts easily: Bolts on any flat surface (e.g., truck bed or frame).
- 1" x 6' (2.5 cm x 1.8 m) tie-down strap with heavy-duty stitching that delivers a 500 lb (226 kg) working load strength and 1,500 lb (680 kg) break strength.
- Convenient retractable push button automatically slackens, spools and stores away strap, while the ratchet mechanism tightens the strap snugly to secure your vehicle or load into place.
- Rubber ratcheting handle provides firm grip, and the hook is vinyl coated to protect whatever surface it hooks into.
- Sold in pairs.

295100737  
**\$39.99**



### RATCHET TIE-DOWNS

- 400 lb (181 kg) safe working load.
- 1" x 10' (2.5 cm x 3 m) strap with Sea-Doo, Ski-Doo and Can-Am logos.
- Deluxe ratchet with rubber handle.
- Coated S hooks.
- Pack of 2.

**860200447 Black/Grey**  
**\$22.99**



**SCS WRAP KITS: PERFECTLY-SIZED AND EXCLUSIVE WRAP DESIGNS\* THAT WILL COMPLEMENT YOUR DEFENDER AND REFRESH ITS LOOK. YOU'RE UNIQUE. YOUR RIDE SHOULD BE TOO.**

Available at participating Can-Am dealers and [scscanamgraphics.com](http://scscanamgraphics.com)



\*SCS wraps are of the highest quality, made with 0.004" (0.01 cm) engineering-grade vinyl overlaid with a 0.008" (0.02 cm) UV-protective laminate. That means vibrant colors, easy installation and a wrap that will hold up to the rigors of the Off-Road. SCS can even customize the color combinations; adding names, numbers and logos according to your exact specifications. Available for both 2-seat and 4-seat Defender models.

# TIRES & RIMS



WITHOUT TRACTION, THERE'S NOTHING—FIT THE BEST TIRES AND WHEELS ON YOUR DEFENDER AND SEE ALL IT CAN DO.

## TIRES

### ITP CRYPTID

- Graduated lug height and paddle-like shoulder configuration provide maximum side bite for climbing in and out of the mud without compromising ride comfort on trails and hard pack.
- 6-ply rated.

**Defender X mr**  
 Front - 30" x 9" x 14"  
 705402504  
**\$230.99**  
 Rear - 30" x 11" x 14"  
 705502913  
**\$250.99**



### MAXXIS BIGHORN 2.0 TIRE

**Defender (XT, XT Cab)**  
 Front - 27" x 9" x 14"  
 705402168  
**\$240.99**  
 705400961 • **\$245.99**  
 Rear - 27" x 11" x 14"  
 705502665  
**\$245.99**  
 705501295 • **\$250.99**



### MAXXIS M923J / M924J

**Defender (Base & DPS models only)**  
 Front - 25" x 8" x 12"  
 705402107  
**\$158.99**  
 Rear - 25" x 10" x 12"  
 705502626  
**\$168.99**



## RIMS

### 14" RIM

- Black with clear coat aluminum rim.
- Choice of beadlock color (not included).
- Needs 16 bolts (250000435) for installing the beadlock.

**Defender, Defender MAX**  
 Front - 14" x 6.5" offset = 41 mm  
 705401594  
**\$276.99**

Rear - 14" x 8" offset = 51 mm  
 705502146  
**\$276.99**



### 14" BEADLOCK RINGS

- Cast aluminum beadlock.
- Must be installed on Front Rim (705401594) and Rear Rim (705502146).

**Defender, Defender MAX**  
 705401586 • Manta Green  
 705401702 • Octane Blue  
 705401837 • Can-Am Red  
 705401840 • Black  
**\$87.99**

### 12" RIM

- Black with clear coat aluminum rim.
- Choice of beadlock color (not included).
- Needs 16 bolts (250000435) for installing the beadlock.

**Defender, Defender MAX**  
 Front - 12" x 6" offset = 41 mm  
 705401678 • Black  
**\$245.99**

Rear - 12" x 7.5" offset = 51 mm  
 705502244 • Black  
**\$245.99**



### 12" BEADLOCK RINGS

- Cast aluminum beadlock.
- Must be installed on Front Rim (705401678) and Rear Rim (705502244).

**Defender, Defender MAX**  
 705401816 • Can-Am Red  
 705401815 • Orange Crush  
 705401814 • Yellow  
 705401695 • Octane Blue  
**\$84.99**

**NOTE:**  
 Matching Nuts - 250100184  
 Matching Cap - 705400928

### DEFENDER CAST-ALUMINUM 14" RIM

**Defender, Defender MAX**  
 Front - 14" x 7" offset = 41 mm  
 705402338 • Black  
**\$184.99**

Rear - 14" x 8.5" offset = 51 mm  
 705502778 • Black  
**\$169.99**

**NOTE:**  
 Matching Nuts - 250100184  
 Matching Cap - 705401541

### LONE STAR CAST-ALUMINUM 14" RIM

**Defender, Defender MAX**  
 Front - 14" x 7" offset = 41 mm  
 705402334  
**\$184.99**

Rear - 14" x 8.5" offset = 51 mm  
 705502775  
**\$199.99**

**NOTE:**  
 Matching Nuts - 250100184  
 Matching Cap - 705401541

### OUTLANDER X MR AND DEFENDER RIM

- Cast aluminum rim with trendsetting explosive styling so you can ride – and look – like a trailblazer.

**Defender, Defender MAX (front wheels)**  
 Front - 14" x 6.5" offset = 10 mm  
 705401848 • Black and machined  
 705401849 • Black  
**\$169.99**

**Defender, Defender MAX (rear wheels)**  
 Rear - 14" x 8.5" offset = 23 mm  
 705502397 • Black and machined  
 705502398 • Black  
**\$169.99**



**NOTE:**  
 Matching Nuts - 250100184 Black, 250100185 Chrome  
 Matching Cap - 705401541

### DEFENDER RIM

(Not illustrated)  
 Front - 14" x 7" offset = 41 mm  
 705402120 • Black  
**\$184.99**

705402118 • Silver and machined  
 705402121 • Black and machined  
**\$184.99**

Rear - 14" x 8.5" offset = 51 mm  
 705502637 • Black  
**\$199.99**

705502634 • Silver and machined  
**\$199.99**  
 705502635 • Black and machined  
**\$184.99**

**NOTE:**  
 Matching Nuts - 250100184 Black, 250100185 Chrome  
 Matching Cap - 705401541

\*Consult your operator's guide/owner's manual for proper tire type and rim sizing. Improper tire type and rim selection may affect vehicle handling. Check with your local authorities for proper regulation.

\*Consult your operator's guide/owner's manual for proper tire type and rim sizing. Improper tire type and rim selection may affect vehicle handling. Check with your local authorities for proper regulation.

# APPAREL

Clothing, helmets, glasses and everything else you need to shift your Can-Am experience into high gear.

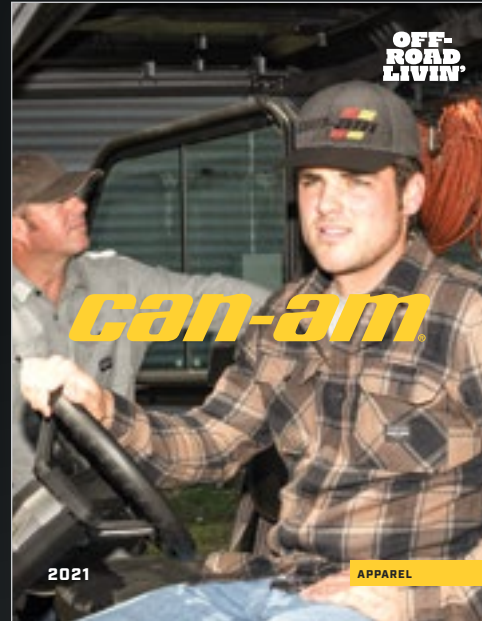

# PARTS & MAINTENANCE

Essential items to keep your Can-Am tearing up the tarmac, including oils, filters maintenance products and cleaning products.



EXPLORE AN ENTIRE WORLD OF ADVENTURE WITH ALL OF OUR BRP PRODUCTS. [BRP.COM](http://BRP.COM)



*ski-doo LYNX SEA-DOO can-am ROTAX ALUMACRAFT Manitou EVIRUDE*





CAN-AMOFFROAD.COM

